

AIR CONDITIONER

Duct type

DESIGN & TECHNICAL MANUAL

INDOOR



ARXG45KHTA
ARXG54KHTA

OUTDOOR



AOYG45KRTA
AOYG54KRTA

FUJITSU GENERAL LIMITED

Notices:

- Product specifications and design are subject to change without notice for future improvement.
- For further details, please check with our authorized dealer.

Trademarks

FGLair™ is trademark of Fujitsu General Limited in the United States, other countries or both.

Google Play™ is trademark of Google LLC.

App Store® is a service mark of Apple Inc., registered in the U.S. and other countries.

CONTENTS

Part 1. INDOOR UNIT	1
1. Specifications	2
2. Dimensions	3
2-1. Models: ARXG45KHTA and ARXG54KHTA.....	3
2-2. Installation space requirement.....	4
2-3. Maintenance space requirement.....	5
3. Wiring diagrams	6
3-1. Models: ARXG45KHTA and ARXG54KHTA.....	6
4. Capacity table	7
4-1. Cooling capacity.....	7
4-2. Heating capacity.....	8
5. Fan performance	9
5-1. Fan performance curve.....	9
5-2. Airflow.....	13
6. Operation noise (sound pressure)	15
6-1. Noise level curve.....	15
6-2. Sound level check point.....	16
7. Safety devices	17
8. External input and output	18
8-1. Preparation.....	18
8-2. External input.....	19
8-3. External output.....	20
9. Function settings	24
9-1. Models: ARXG45KHTA and ARXG54KHTA.....	24
9-2. Function settings by using remote controller.....	26
10. Accessories	29
10-1. Models: ARXG45KHTA and ARXG54KHTA.....	29
11. Optional parts	30
11-1. Controllers.....	30
11-2. Others.....	31

CONTENTS (continued)

Part 2. OUTDOOR UNIT	33
1. Specifications	34
2. Dimensions	35
2-1. Models: AOYG45KRTA and AOYG54KRTA.....	35
3. Installation space	36
3-1. Models: AOYG45KRTA and AOYG54KRTA.....	36
4. Refrigerant circuit	39
4-1. Models: AOYG45KRTA and AOYG54KRTA.....	39
5. Wiring diagrams	40
5-1. Models: AOYG45KRTA and AOYG54KRTA.....	40
6. Capacity compensation rate for pipe length and height difference	41
6-1. Models: AOYG45KRTA and AOYG54KRTA.....	41
7. Additional charge calculation	42
7-1. Models: AOYG45KRTA and AOYG54KRTA.....	42
8. Airflow	43
8-1. Models: AOYG45KRTA and AOYG54KRTA.....	43
9. Operation noise (sound pressure)	44
9-1. Noise level curve.....	44
9-2. Sound level check point.....	45
10. Electrical characteristics	46
11. Safety devices	47
12. External input and output	48
12-1.External input.....	48
12-2.External output.....	50
13. Function settings	52
13-1.Control PCB and switch buttons location.....	52
13-2.Local setting procedure.....	54
14. Accessories	56
14-1.Models: AOYG45KRTA and AOYG54KRTA.....	56
15. Optional parts	57

Part 1. INDOOR UNIT

DUCT TYPE:

ARXG45KHTA

ARXG54KHTA

1. Specifications

Type			Duct			
			Inverter heat pump			
Model name			ARXG45KHTA	ARXG54KHTA		
Power supply			3N 400 V ~ 50 Hz			
Power supply intake			Outdoor unit			
Available voltage range			342—457 V			
Capacity	Cooling	Rated	kW	12.1	13.4	
			Btu/h	41,300	45,700	
		Min.—Max.	kW	4.0—14.0	5.0—14.5	
		Btu/h	13,600—47,800	17,100—49,400		
	Heating	Rated	kW	13.5	15.5	
			Btu/h	46,100	52,900	
Min.—Max.		kW	5.0—16.2	5.5—18.0		
	Btu/h	17,100—55,300	18,800—61,400			
Input power	Cooling	Rated	kW	4.16	4.77	
		Max.		5.22	5.59	
	Heating	Rated		3.61	4.18	
		Max.		5.07	5.67	
Current	Cooling	Rated	A	7.6	8.5	
	Heating	Rated		6.8	7.6	
Power factor	Cooling		%	79.4	81.7	
	Heating			77.4	79.5	
EER	Cooling		kW/kW	2.91	2.81	
COP	Heating			3.74	3.71	
Moisture removal			L/h (pints/h)	1.5 (2.6)	2.0 (3.5)	
Maximum operating current*1		Cooling	A	14		
		Heating		14		
Fan	Airflow rate	Cooling	m ³ /h	HIGH	3,350	
				MED	2,850	
				LOW	2,430	
		Heating		HIGH	3,350	
				MED	2,850	
				LOW	2,430	
	Type × Q'ty		Sirocco fan × 2			
Motor output		W	490			
Static pressure range			Pa	100 to 250		
Sound pressure level*2	Cooling	HIGH	dB (A)	47		
				MED	43	
				LOW	40	
	Heating	HIGH		47		
				MED	43	
				LOW	40	
Heat exchanger type	Dimensions (H × W × D)		mm	336 × 890 × 53.2		
	Fin pitch			1.3		
	Rows × Stages			4 × 16		
	Pipe type			Copper		
	Fin type			Aluminum		
Enclosure	Material		Steel sheet			
	Color		—			
Dimensions (H × W × D)	Net		mm	400 × 1,050 × 500		
	Gross			460 × 1,230 × 640		
Weight	Net		kg	46		
	Gross			51		
Connection pipe	Size	Liquid	mm (in)	Ø9.52 (3/8)		
		Gas		Ø15.88 (5/8)		
	Method			Flare		
Operation range	Cooling		°C	18 to 32		
		%RH		80 or less		
	Heating			°C	16 to 30	
Drain port	Material		PVC			
	Tip diameter		mm	Ø26.0 (I.D.), Ø32.0 (O.D.)		
Drain hose	Material		PVC			
	Tip diameter		mm	Ø25.0 (I.D.), Ø32.0 (O.D.)		
Remote control (Option)			Wired remote controller, Wireless remote controller, Mobile app*3 (FGLair™)			

NOTES:

- Specifications are based on the following conditions:
 - Cooling: Indoor temperature of 27 °CDB/19 °CWB, and outdoor temperature of 35 °CDB/24 °CWB.
 - Heating: Indoor temperature of 20 °CDB/15 °CWB, and outdoor temperature of 7 °CDB/6 °CWB.
 - Pipe length: 5 m, Height difference: 0 m. (Between outdoor unit and indoor unit.)
 - Standard static pressure: 100 Pa
- Protective function might work when using it outside the operation range.
- *1: Maximum operating current is the total current of the indoor unit and the outdoor unit.
- *2: Sound pressure level:
 - Measured values in manufacturer's anechoic chamber.
 - Because of the surrounding sound environment, the sound levels measured in actual installation conditions might be higher than the specified values here.
- *3: Available on Google Play™ store or on App Store®. Optional WLAN Adapter is also required. For details, refer to the setting manual.
- This data is based on EN 14511 standard.

2. Dimensions

2-1. Models: ARXG45KHTA and ARXG54KHTA

Unit: mm

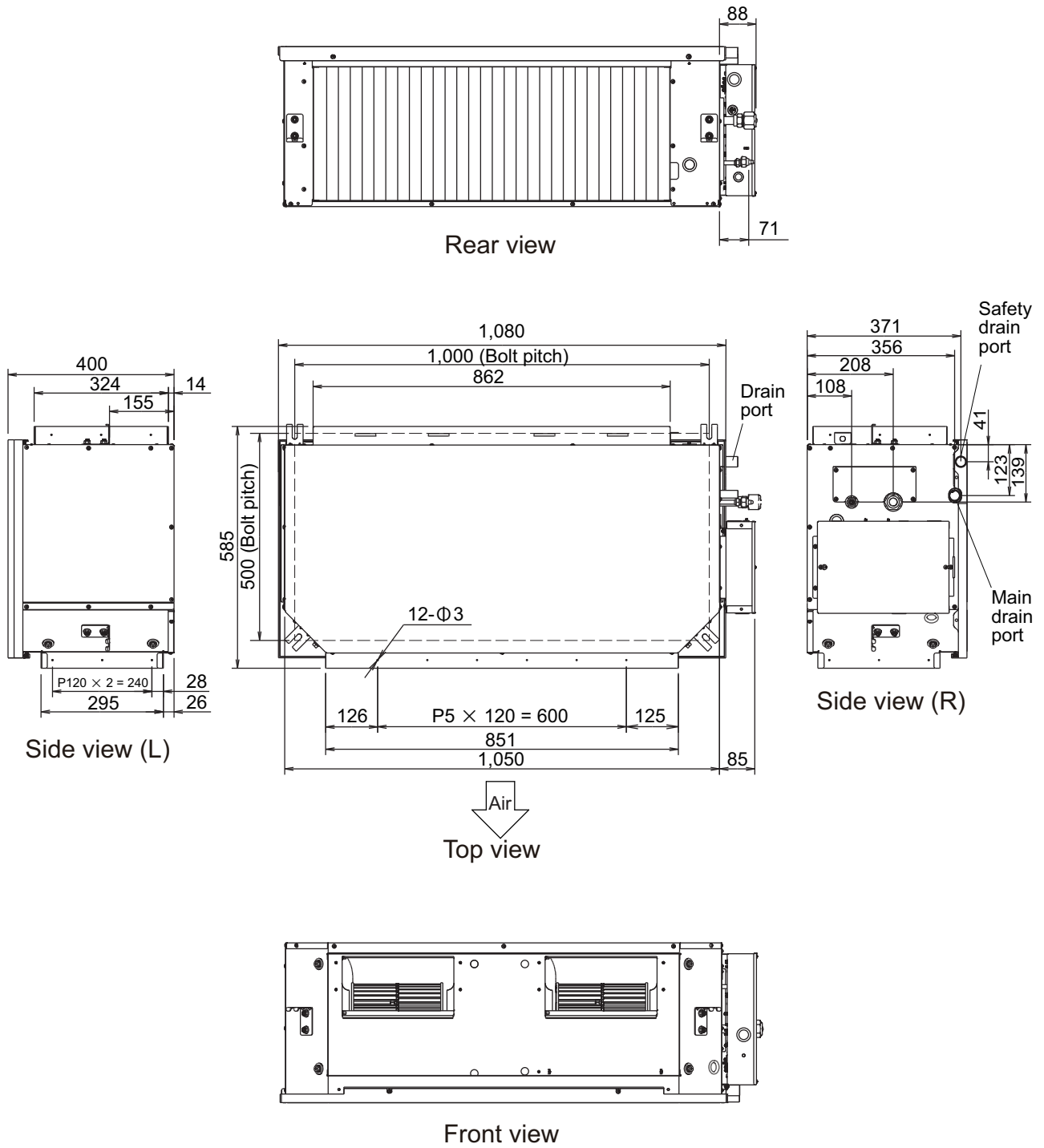

2-2. Installation space requirement

Provide sufficient installation space for product safety.

■ Models: ARXG45KHTA and ARXG54KHTA

Installation by which maintenance space is made on top of the unit (recommended).

Unit: mm

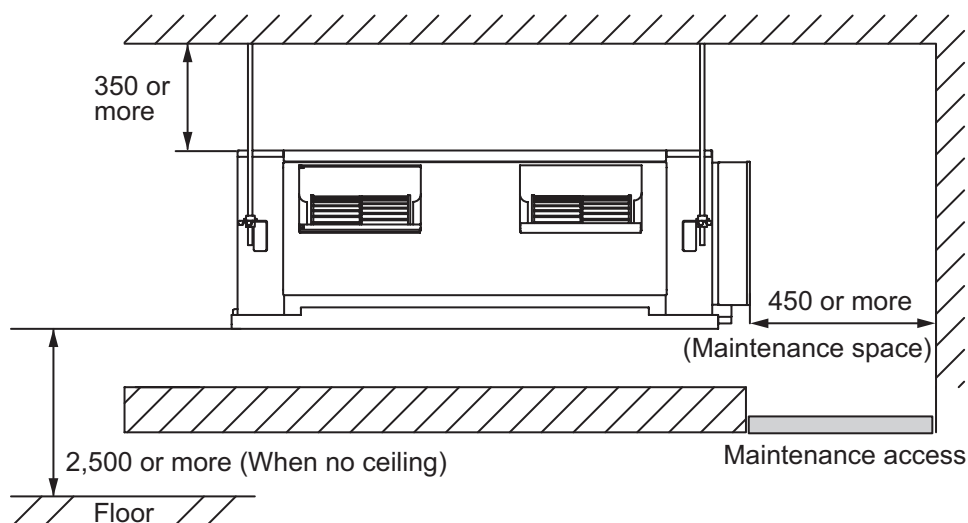

Installation by which maintenance space is carried out from the bottom of the unit.

Unit: mm

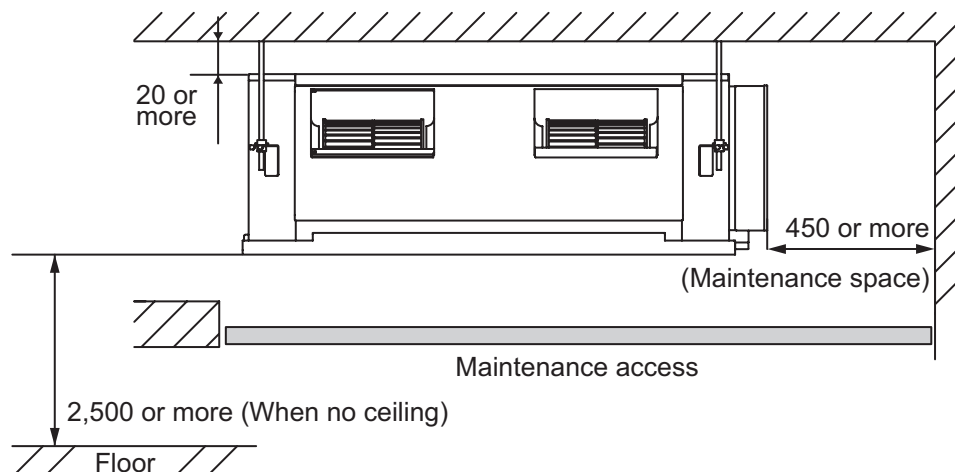

2-3. Maintenance space requirement

For future maintenance and service access, provide sufficient maintenance space.

NOTE: Do not place any wiring or illumination in the maintenance space, as they will impede service.

■ Models: ARXG45KHTA and ARXG54KHTA

Unit: mm

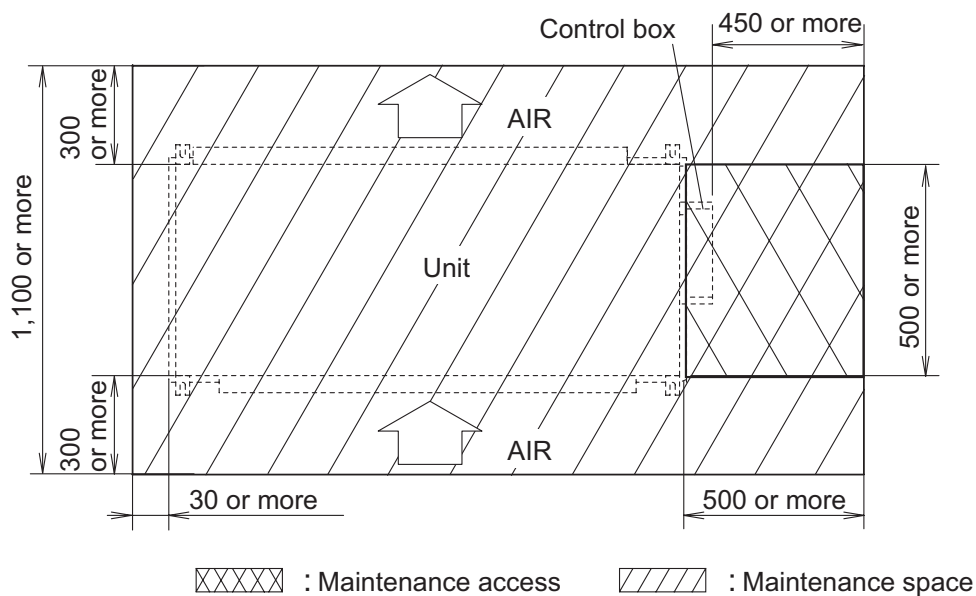

3. Wiring diagrams

3-1. Models: ARXG45KHTA and ARXG54KHTA

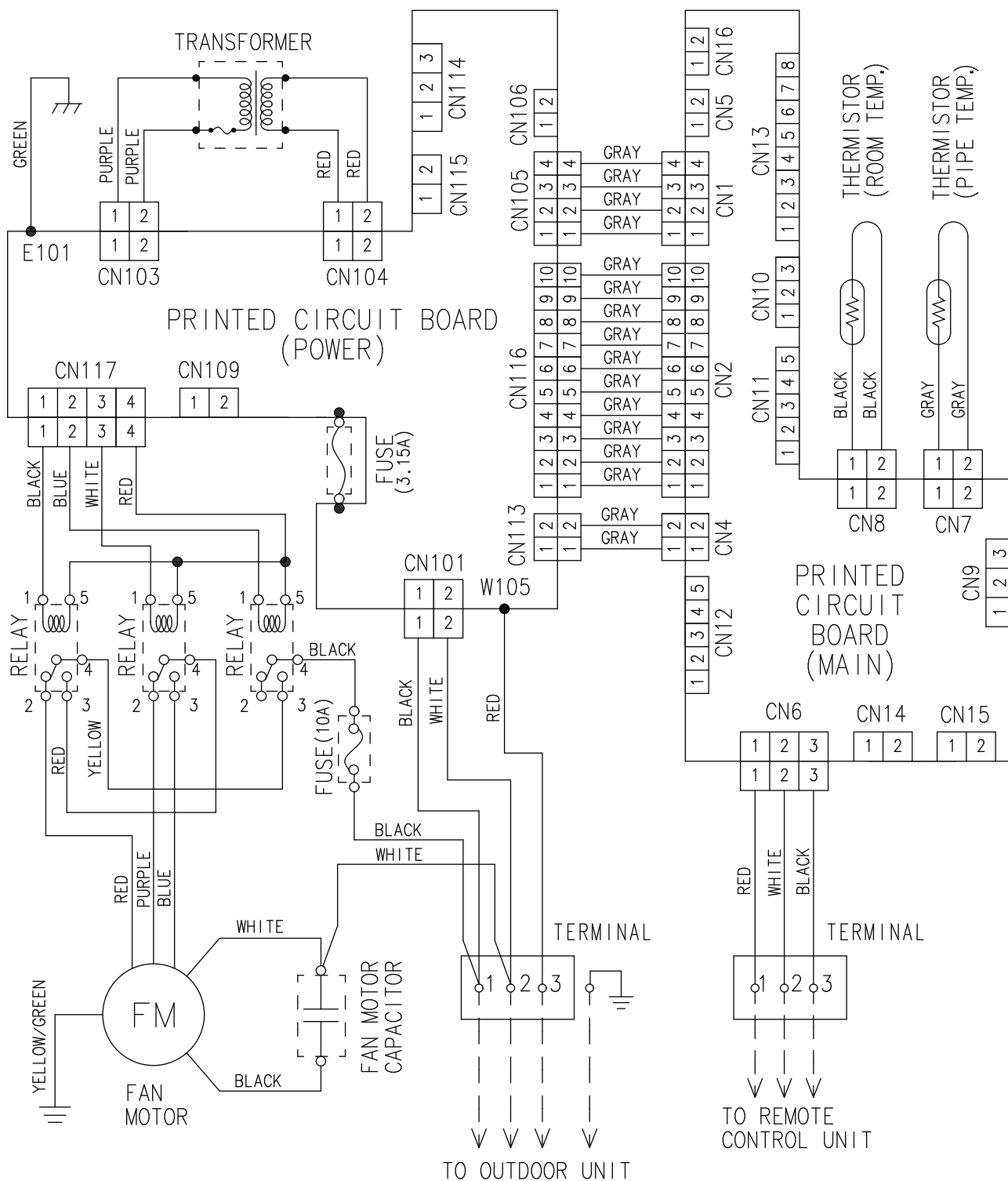

4. Capacity table

Capacity tables show each of following values calculated based on the outdoor temperature and the indoor temperature, under given Airflow Rate (AFR):

For cooling capacity: Total Capacity (TC), Sensible Heat Capacity (SHC), and Input Power (IP)

For heating capacity: Total Capacity (TC) and Input Power (IP)

4-1. Cooling capacity

■ ARXG45KHTA

AFR			m ³ /h															3,350				
Outdoor temperature	Indoor temperature																					
	°CDB	18			21			23			25			27			29			32		
	°CWB	12			15			16			18			19			21			23		
	°CDB	TC	SHC	IP	TC	SHC	IP	TC	SHC	IP	TC	SHC	IP	TC	SHC	IP	TC	SHC	IP	TC	SHC	IP
		kW			kW			kW			kW			kW			kW			kW		
-15	8.48	7.52	1.67	9.20	7.90	1.71	9.68	8.15	1.74	10.16	8.49	1.76	10.64	8.83	1.78	11.08	9.00	1.78	11.75	9.24	1.78	
-10	8.56	7.56	1.70	9.29	7.94	1.74	9.77	8.19	1.76	10.26	8.53	1.79	10.74	8.88	1.81	11.19	9.04	1.81	11.86	9.29	1.81	
0	8.73	7.63	1.75	9.47	8.02	1.79	9.96	8.27	1.82	10.46	8.62	1.84	10.95	8.96	1.87	11.41	9.13	1.87	12.09	9.38	1.87	
5	8.57	7.56	1.80	9.30	7.94	1.84	9.78	8.19	1.86	10.27	8.54	1.89	10.76	8.88	1.92	11.20	9.05	1.92	11.88	9.29	1.92	
10	8.42	7.49	1.84	9.13	7.87	1.88	9.61	8.12	1.91	10.08	8.46	1.94	10.56	8.80	1.96	11.00	8.96	1.96	11.66	9.21	1.96	
15	8.27	7.37	1.89	8.98	7.74	1.94	9.45	7.99	1.96	9.91	8.32	1.99	10.38	8.66	2.02	10.82	8.82	2.02	11.47	9.05	2.02	
20	11.05	9.41	3.54	11.99	9.88	3.62	12.61	10.20	3.67	13.24	10.62	3.72	13.86	11.05	3.78	14.44	11.25	3.78	15.31	11.56	3.78	
25	10.58	9.17	3.66	11.48	9.63	3.74	12.08	9.94	3.80	12.68	10.36	3.85	13.28	10.77	3.90	13.83	10.97	3.90	14.66	11.27	3.90	
30	10.11	8.94	3.78	10.97	9.39	3.86	11.54	9.68	3.92	12.12	10.09	3.98	12.69	10.49	4.03	13.22	10.69	4.03	14.01	10.98	4.03	
35	9.64	8.70	3.90	10.46	9.14	3.99	11.01	9.43	4.04	11.55	9.82	4.10	12.10	10.22	4.16	12.61	10.40	4.16	13.36	10.69	4.16	
40	8.22	7.68	3.51	8.92	8.06	3.59	9.38	8.32	3.64	9.85	8.67	3.70	10.32	9.02	3.75	10.75	9.18	3.75	11.39	9.43	3.75	
46	6.51	6.45	3.05	7.07	6.78	3.12	7.44	6.99	3.16	7.80	7.28	3.21	8.17	7.58	3.25	8.51	7.72	3.25	9.03	7.93	3.25	

■ ARXG54KHTA

AFR			m ³ /h															3,350				
Outdoor temperature	Indoor temperature																					
	°CDB	18			21			23			25			27			29			32		
	°CWB	12			15			16			18			19			21			23		
	°CDB	TC	SHC	IP	TC	SHC	IP	TC	SHC	IP	TC	SHC	IP	TC	SHC	IP	TC	SHC	IP	TC	SHC	IP
		kW			kW			kW			kW			kW			kW			kW		
-15	9.58	8.34	1.89	10.39	8.76	1.93	10.94	9.04	1.96	11.48	9.42	1.99	12.02	9.80	2.02	12.52	9.98	2.02	13.28	10.25	2.02	
-10	9.61	8.34	1.91	10.42	8.76	1.95	10.97	9.04	1.98	11.51	9.42	2.01	12.06	9.80	2.03	12.56	9.99	2.03	13.32	10.26	2.03	
0	9.66	8.35	1.94	10.48	8.77	1.98	11.03	9.05	2.01	11.58	9.43	2.04	12.13	9.81	2.07	12.63	10.00	2.07	13.39	10.27	2.07	
5	9.49	8.23	1.99	10.30	8.65	2.03	10.84	8.93	2.06	11.37	9.30	2.09	11.91	9.68	2.12	12.41	9.86	2.12	13.15	10.13	2.12	
10	9.32	8.12	2.04	10.11	8.53	2.08	10.64	8.80	2.11	11.17	9.17	2.14	11.70	9.54	2.17	12.18	9.72	2.17	12.92	9.98	2.17	
15	9.16	7.98	2.10	9.94	8.39	2.14	10.46	8.66	2.17	10.98	9.02	2.21	11.50	9.38	2.24	11.98	9.56	2.24	12.70	9.82	2.24	
20	12.24	10.29	4.06	13.27	10.81	4.15	13.97	11.16	4.21	14.66	11.63	4.27	15.35	12.10	4.33	16.00	12.32	4.33	16.96	12.66	4.33	
25	11.72	10.03	4.20	12.71	10.54	4.29	13.38	10.88	4.35	14.04	11.33	4.41	14.70	11.79	4.48	15.32	12.01	4.48	16.24	12.34	4.48	
30	11.20	9.77	4.33	12.15	10.27	4.43	12.78	10.60	4.49	13.42	11.04	4.56	14.05	11.49	4.62	14.64	11.70	4.62	15.52	12.02	4.62	
35	10.68	9.51	4.47	11.59	9.99	4.57	12.19	10.32	4.64	12.80	10.75	4.70	13.40	11.18	4.77	13.96	11.39	4.77	14.80	11.70	4.77	
40	9.10	8.41	4.03	9.88	8.84	4.12	10.39	9.12	4.18	10.91	9.50	4.24	11.42	9.89	4.30	11.90	10.07	4.30	12.62	10.35	4.30	
46	7.21	7.09	3.50	7.83	7.45	3.57	8.23	7.69	3.63	8.64	8.01	3.68	9.05	8.34	3.73	9.43	8.49	3.73	10.00	8.72	3.73	

4-2. Heating capacity

NOTE: Values mentioned in the table are calculated based on the maximum capacity.

■ ARXG45KHTA

AFR	m ³ /h	3,350
-----	-------------------	-------

		Indoor temperature											
		°CDB		16		18		20		22		24	
		°CDB	°CWB	TC	IP	TC	IP	TC	IP	TC	IP	TC	IP
Outdoor temperature	-15	-16	12.04	4.43	11.75	4.45	11.46	4.48	11.19	4.48	10.53	4.48	
	-10	-11	13.37	4.62	13.05	4.64	12.73	4.67	12.43	4.67	11.69	4.67	
	-5	-7	14.70	4.81	14.35	4.83	14.00	4.86	13.67	4.86	12.86	4.86	
	0	-2	15.48	4.99	15.11	5.02	14.74	5.05	14.40	5.05	13.54	5.05	
	5	3	16.57	4.84	16.18	4.86	15.78	4.89	15.42	4.89	14.50	4.89	
	7	6	17.01	4.83	16.61	4.85	16.20	4.88	15.82	4.88	14.88	4.88	
	10	8	17.72	4.82	17.29	4.84	16.87	4.87	16.48	4.87	15.50	4.87	
	15	10	18.89	4.80	18.44	4.83	17.99	4.85	17.57	4.85	16.53	4.85	
	20	15	20.07	4.78	19.59	4.81	19.11	4.83	18.66	4.83	17.55	4.83	
	24	18	21.01	4.77	20.50	4.80	20.00	4.82	19.54	4.82	18.38	4.82	

■ ARXG54KHTA

AFR	m ³ /h	3,350
-----	-------------------	-------

		Indoor temperature											
		°CDB		16		18		20		22		24	
		°CDB	°CWB	TC	IP	TC	IP	TC	IP	TC	IP	TC	IP
Outdoor temperature	-15	-16	12.95	5.16	12.65	5.19	12.34	5.22	12.05	5.22	11.33	5.22	
	-10	-11	14.39	5.38	14.04	5.41	13.70	5.44	13.38	5.44	12.59	5.44	
	-5	-7	15.82	5.60	15.44	5.63	15.07	5.66	14.72	5.66	13.84	5.66	
	0	-2	17.20	5.82	16.79	5.85	16.38	5.88	16.00	5.88	15.05	5.88	
	5	3	18.42	5.20	17.98	5.23	17.54	5.26	17.13	5.26	16.11	5.26	
	7	6	18.90	5.20	18.45	5.22	18.00	5.25	17.58	5.25	16.54	5.25	
	10	8	19.69	5.18	19.22	5.21	18.75	5.24	18.31	5.24	17.22	5.24	
	15	10	20.99	5.17	20.49	5.19	19.99	5.22	19.52	5.22	18.36	5.22	
	20	15	22.30	5.15	21.76	5.17	21.23	5.20	20.74	5.20	19.50	5.20	
	24	18	23.34	5.13	22.78	5.16	22.23	5.19	21.71	5.19	20.42	5.19	

5. Fan performance

5-1. Fan performance curve

■ ARXG45KHTA

			Static pressure (Pa)								
			50	75	100	125	150	175	200	225	250
Fan speed	HIGH	m3/h	—	—	3,350	3,150	2,950	2,700	2,450	2,280	1,900
		l/s	—	—	931	875	819	750	681	633	528
		CFM	—	—	1,972	1,854	1,736	1,589	1,442	1,342	1,118
	MED	m3/h	—	2,850	2,700	2,520	2,350	2,160	1,970	1,750	—
		l/s	—	792	750	700	653	600	547	486	—
		CFM	—	1,677	1,589	1,483	1,383	1,271	1,159	1,030	—
	LOW	m3/h	2,430	2,310	2,180	2,050	1,900	1,750	—	—	—
		l/s	675	642	606	569	528	486	—	—	—
		CFM	1,430	1,360	1,283	1,207	1,118	1,030	—	—	—

Q-h Characteristic curve

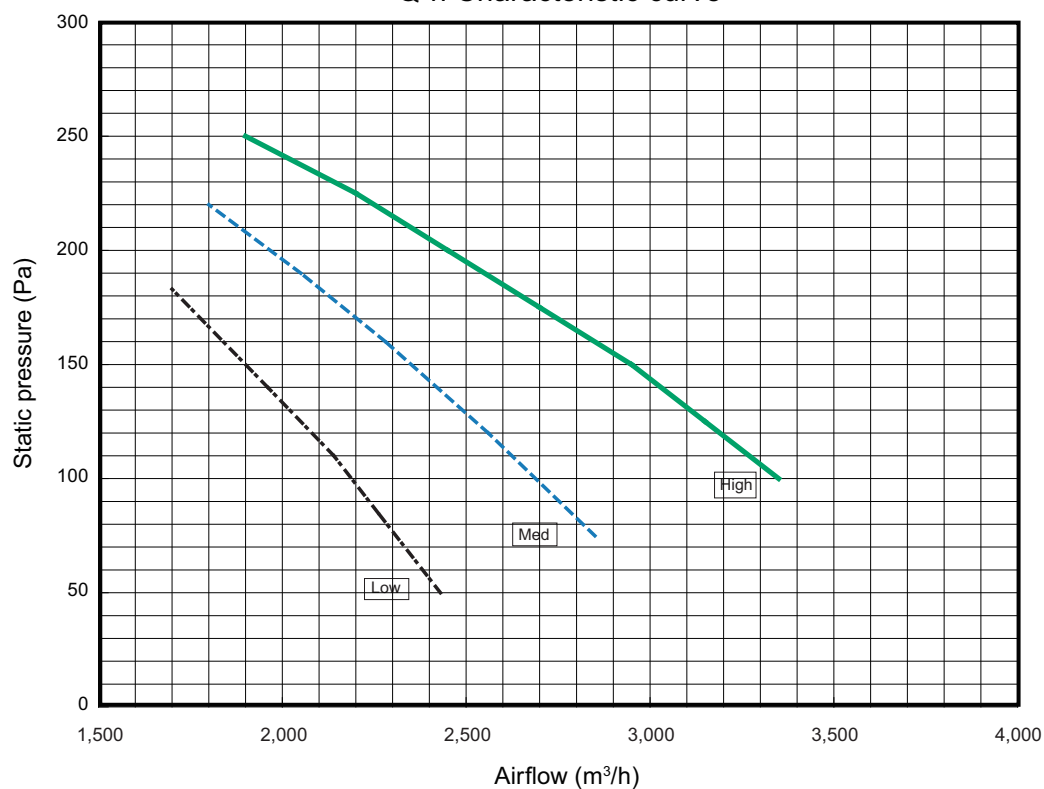

• Cooling

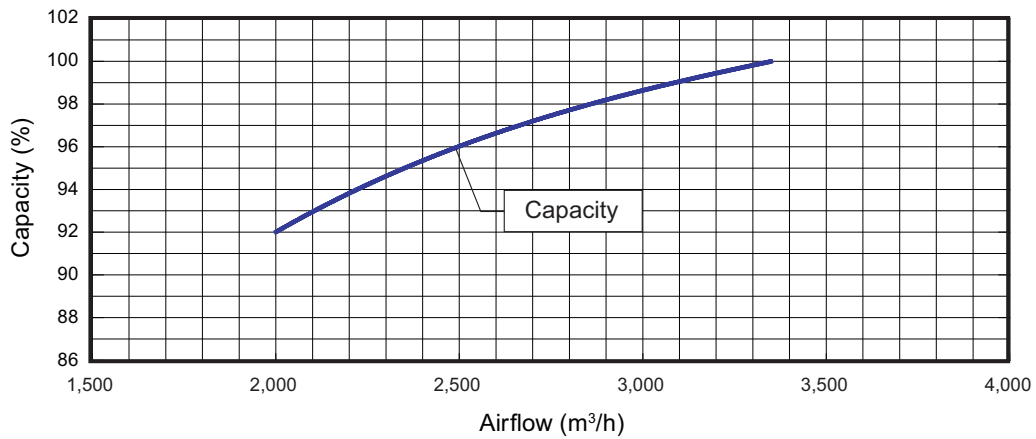

• Heating

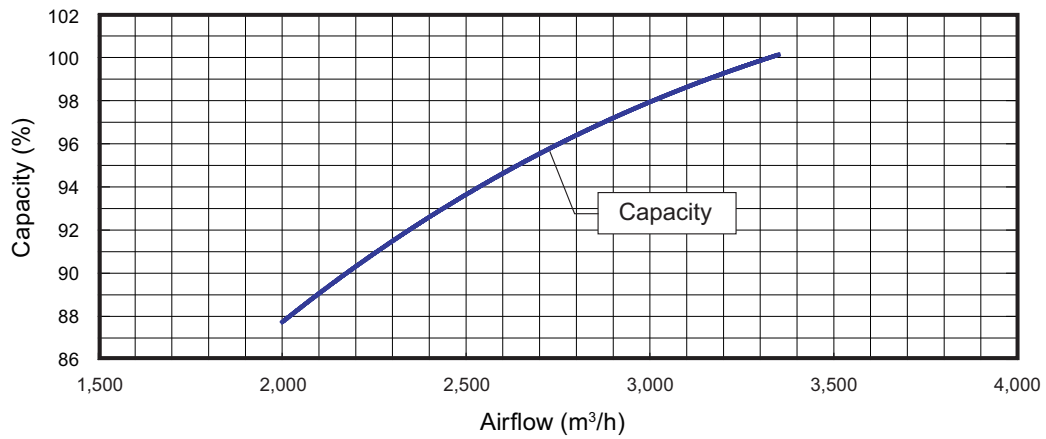

■ ARXG54KHTA

DUCT TYPE
ARXG45, 54KHTA

DUCT TYPE
ARXG45, 54KHTA

			Static pressure (Pa)								
			50	75	100	125	150	175	200	225	250
Fan speed	HIGH	m3/h	—	—	3,350	3,150	2,950	2,700	2,450	2,280	1,900
		l/s	—	—	931	875	819	750	681	633	528
		CFM	—	—	1,972	1,854	1,736	1,589	1,442	1,342	1,118
	MED	m3/h	—	2,850	2,700	2,520	2,350	2,160	1,970	1,750	—
		l/s	—	792	750	700	653	600	547	486	—
		CFM	—	1,677	1,589	1,483	1,383	1,271	1,159	1,030	—
	LOW	m3/h	2,430	2,310	2,180	2,050	1,900	1,750	—	—	—
		l/s	675	642	606	569	528	486	—	—	—
		CFM	1,430	1,360	1,283	1,207	1,118	1,030	—	—	—

Q-h Characteristic curve

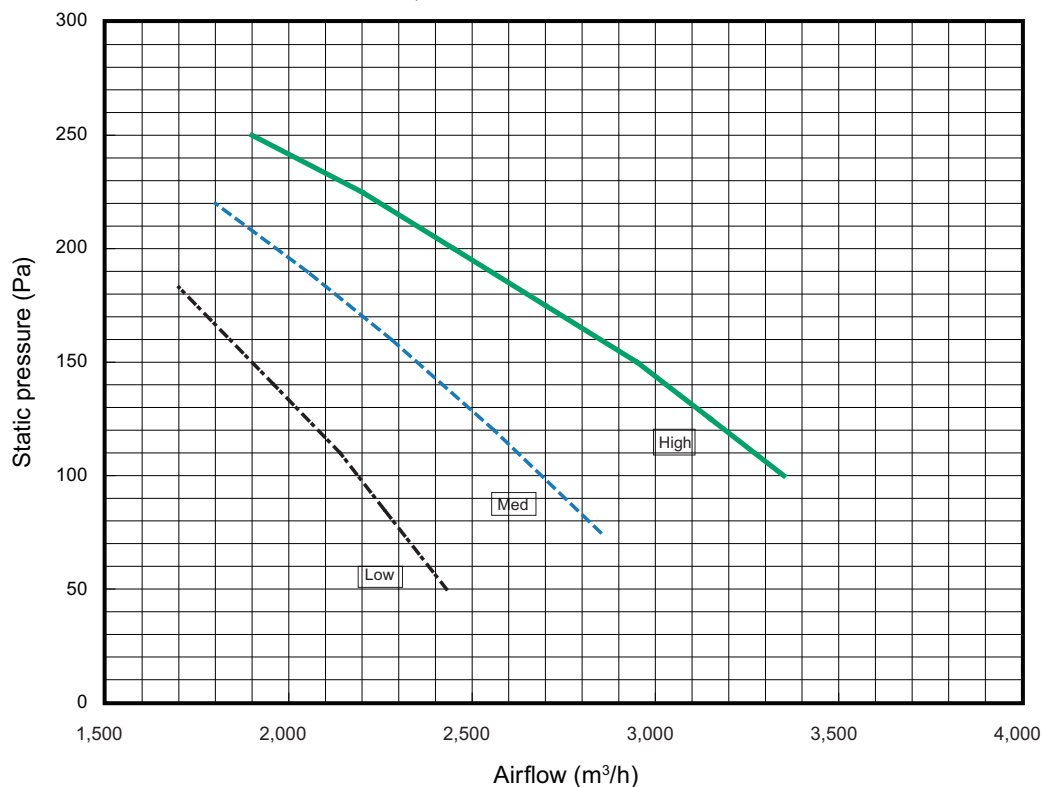

• Cooling

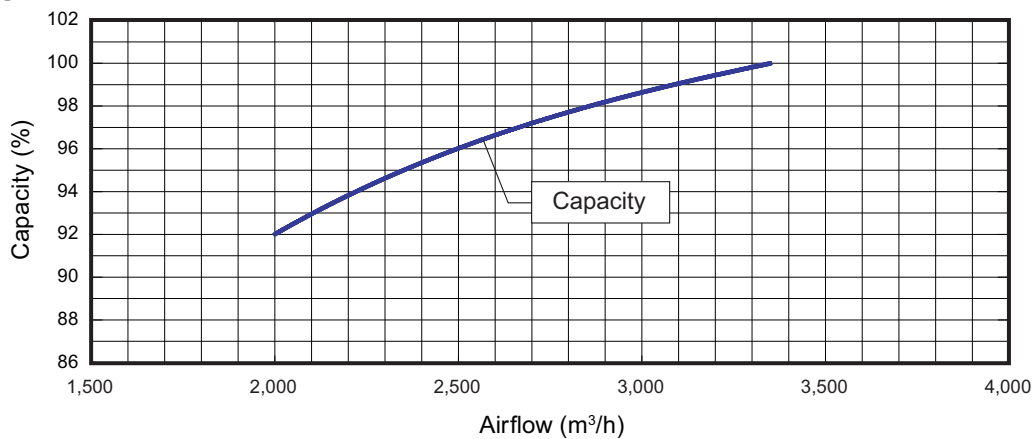

• Heating

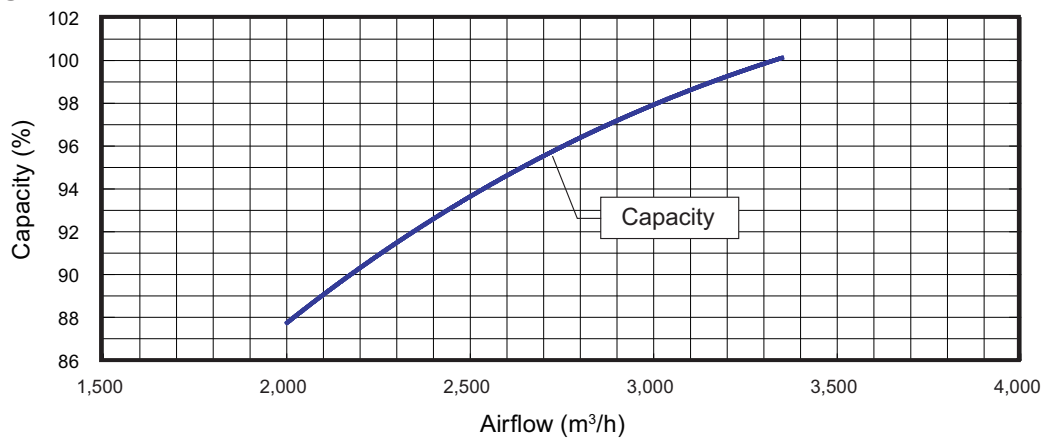

5-2. Airflow

■ ARXG45KHTA

● Cooling

Fan speed	Airflow	
HIGH	m ³ /h	3,350
	l/s	931
	CFM	1,972
MED	m ³ /h	2,850
	l/s	792
	CFM	1,678
LOW	m ³ /h	2,430
	l/s	675
	CFM	1,430

● Heating

Fan speed	Airflow	
HIGH	m ³ /h	3,350
	l/s	931
	CFM	1,972
MED	m ³ /h	2,850
	l/s	792
	CFM	1,678
LOW	m ³ /h	2,430
	l/s	675
	CFM	1,430

■ ARXG54KHTA

● Cooling

Fan speed	Airflow	
HIGH	m ³ /h	3,350
	l/s	931
	CFM	1,972
MED	m ³ /h	2,850
	l/s	792
	CFM	1,678
LOW	m ³ /h	2,430
	l/s	675
	CFM	1,430

● Heating

Fan speed	Airflow	
HIGH	m ³ /h	3,350
	l/s	931
	CFM	1,972
MED	m ³ /h	2,850
	l/s	792
	CFM	1,678
LOW	m ³ /h	2,430
	l/s	675
	CFM	1,430

6. Operation noise (sound pressure)

6-1. Noise level curve

Measuring conditions	Static pressure	Static pressure mode
	100 Pa	Normal

Model: ARXG45KHTA

● Cooling

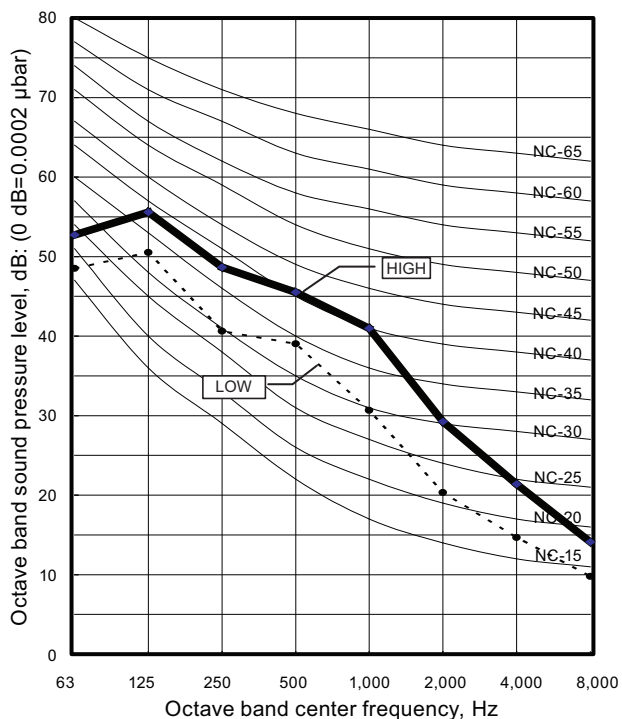

● Heating

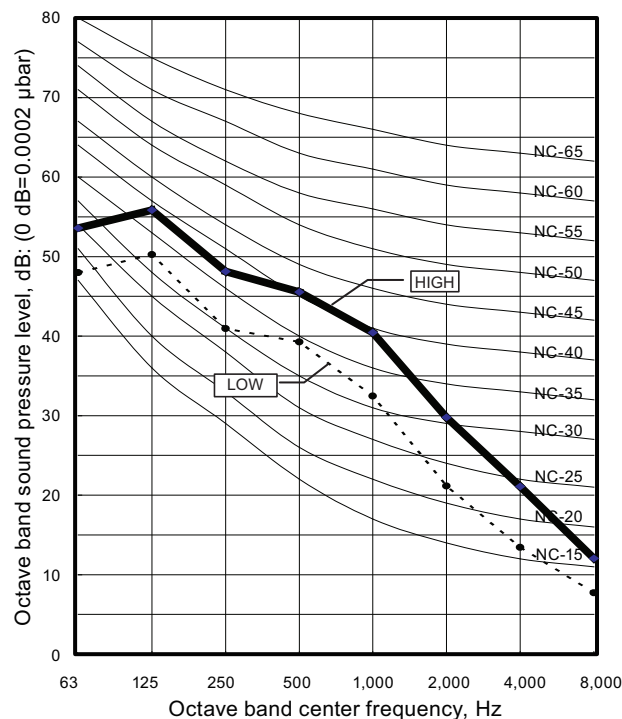

Model: ARXG54KHTA

● Cooling

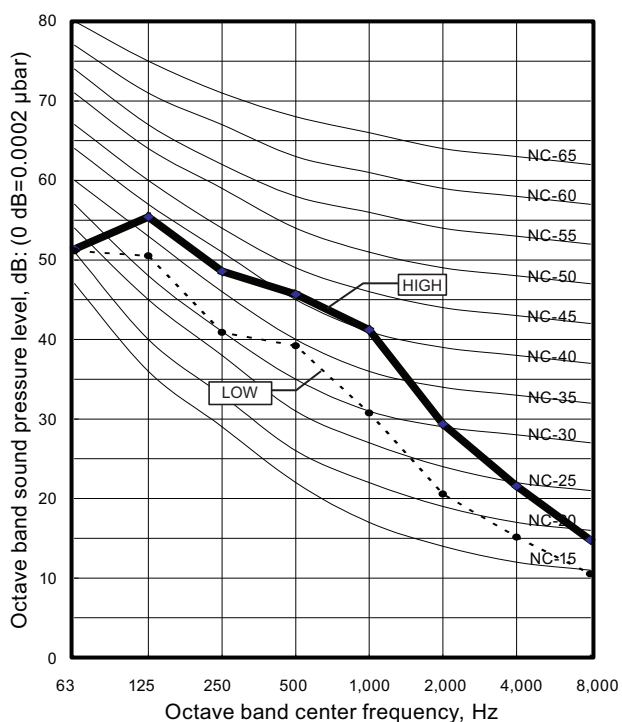

● Heating

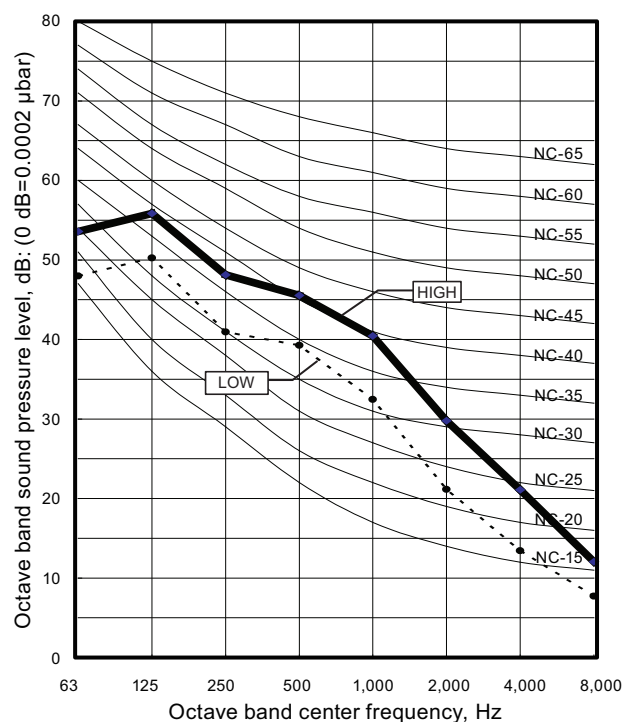

6-2. Sound level check point

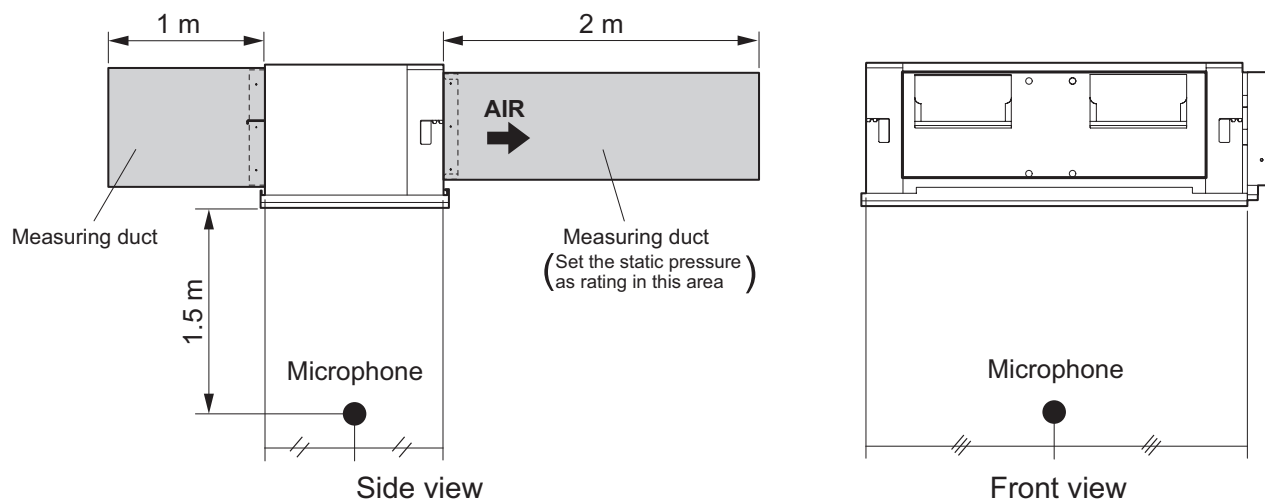

7. Safety devices

Type of protection	Protection form		Model	
			ARXG45KHTA	ARXG54KHTA
Circuit protection	Current fuse (PCB*)		250 V, 3.15 A	
Fan motor protection	Thermal protection program	Activate	145 ±5 °C Fan motor stop	
		Reset	93 ±15 °C Fan motor restart	

*: Printed Circuit Board

8. External input and output

Connector	Input	Output	Remarks
CN114	Control input	—	See external input/output settings for details.
CN115	—	Operation status output	
CN14	—	Fresh air control output	
CN15	—	Auxiliary heater output	

8-1. Preparation

Before connecting the external input, preparation is necessary using the signal wire in the figure below.



When the external input/output is used, connect the external signal wire as shown in the figure.

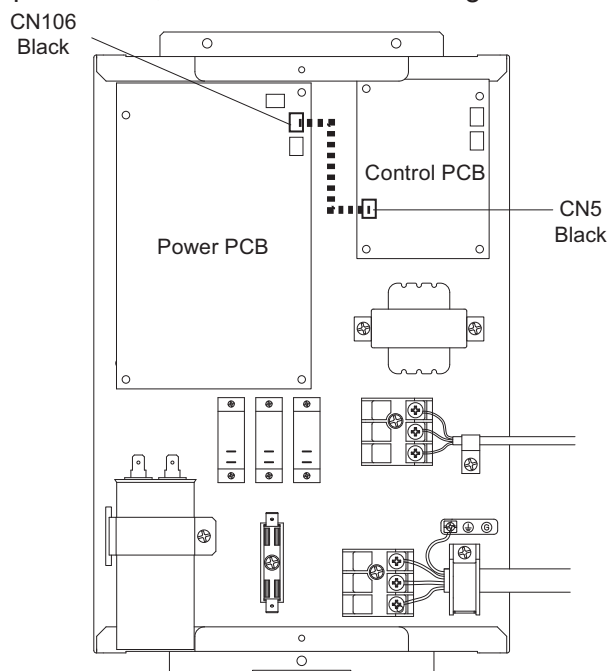

8-2. External input

- "Operation/Stop" mode or "Forced stop" mode can be selected with function setting of indoor unit.
- A twisted pair cable (22AWG) should be used. Maximum length of cable is 150 m.
- The wire connection should be separate from the power cable line.

■ Control input (Operation/Stop or Forced stop)

The air conditioner can be remotely operated by means of the following on-site work.

Operation is started at the following contents by adding the contact input of a commercially available on/off switch to a connector on the external control PCB and turning it ON.

Unit operation	Initial setting after power is on	Starting mode other than initial setting
Operation mode	Auto changeover	Mode at previous operation
Set temperature	24 °C	Temperature at previous operation
Airflow mode	AUTO	Mode at previous operation

● Circuit diagram example

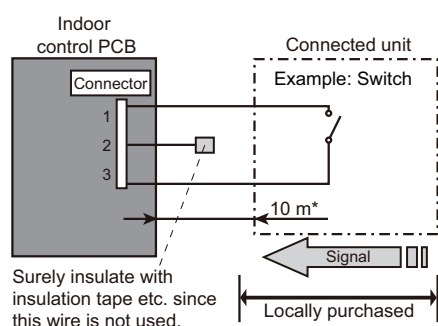

- Contact capacity: DC 5 V or more, 15 mA or more.
- Make the distance from the PCB to the connected unit within 10 m.
- Use non-polar relays and switches.

- When function setting is "Operation/Stop" mode

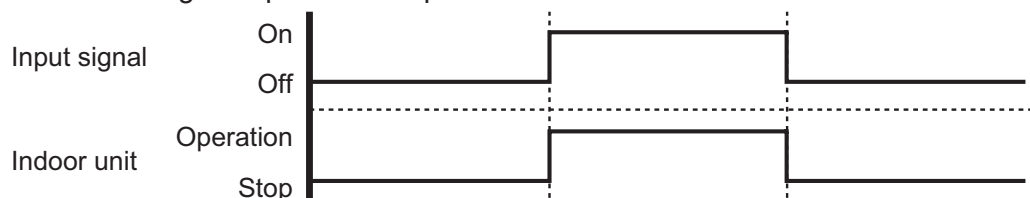

- When function setting is "Forced stop" mode

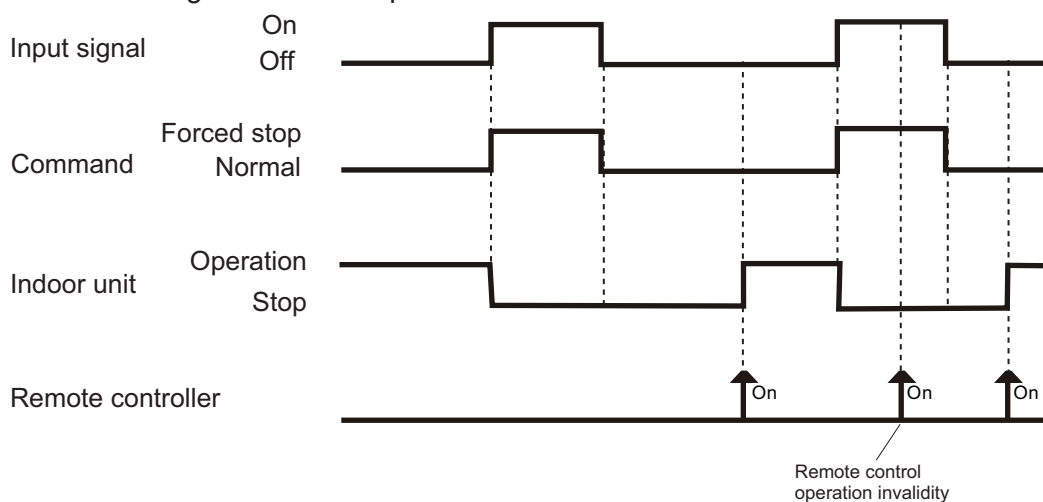

● Optional part

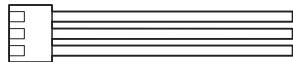
Model name	Exterior
UTD-ECS5A	External input wire 

8-3. External output

With using external output function, operating status of this product can be transmitted to the external device, and also, this product can be inter-connected with the external device.

■ Operation status output

● Circuit diagram example

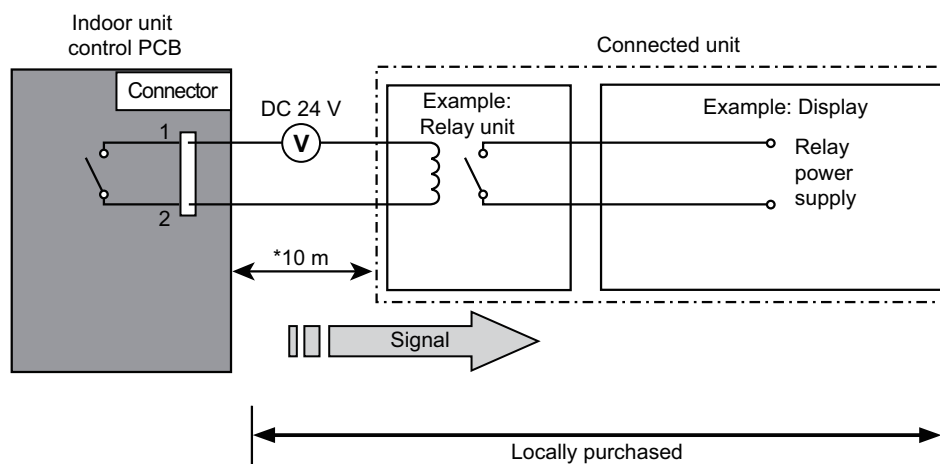

- *: Make the distance from the PCB to the connected unit within 10 m.
- Relay spec: Max. DC 24 V, 10 mA to less than 500 mA.

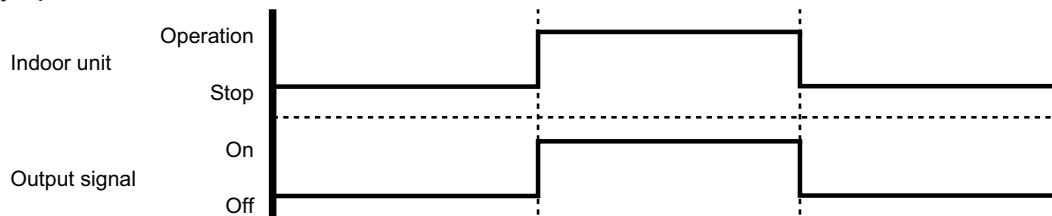

● Optional part

Model name	Exterior
UTD-ECS5A	External output wire 

■ Fresh-air control output

Signal linked to the indoor unit fan on can be output.

NOTE: In cold-air prevention control operation, the signal becomes off.

● Circuit diagram example

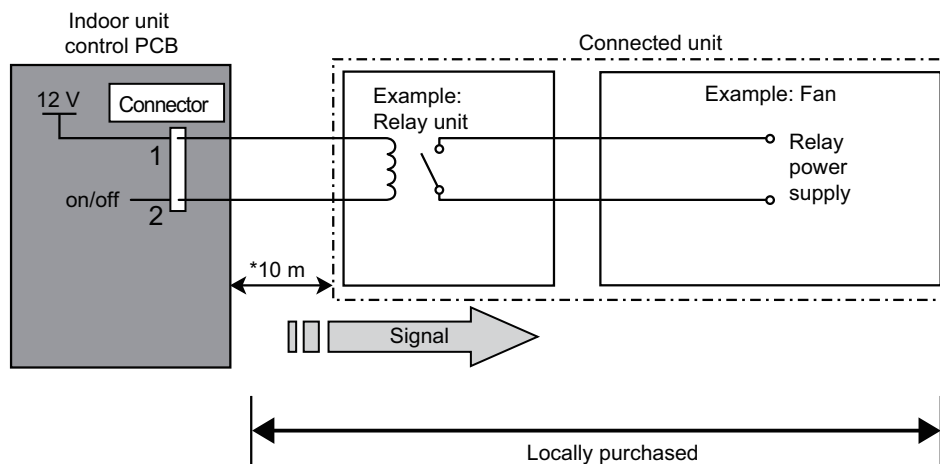

- *: Make the distance from the PCB to the connected unit within 10 m.
- Relay spec: Rated DC 12 V, 50 mA or less.

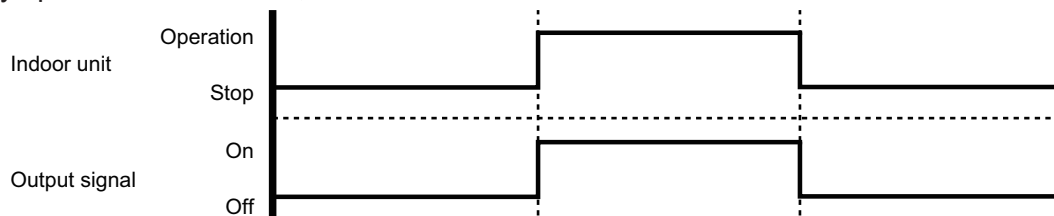

● Optional part

Part name	Model name	Exterior
Fresh Air Intake Kit	UTD-ECS5A	Fresh-air output wire 

■ Auxiliary heater output

When indoor unit fan and compressor is turned on in heating operation, the signal is output from connector.

Specifications of the signal output performance are as shown as follows:

Example: When set temperature (T_s) is set at 22 °C;

- And room temperature (T_r) increase above 12 °C, signal output is ON.
- And T_r increase above 21 °C, signal output is OFF.
- And T_r decrease below 19 °C, signal output is ON.
- And T_r decrease below 10 °C, signal output is OFF.

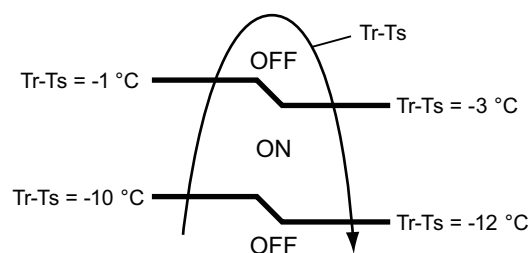

● Fan delay setting

This is used to continue the indoor unit fan operation for 1 minute after thermo OFF in heating mode.

For the detail setting on fan delay setting, refer to "Function settings on indoor unit" in "Function settings" on page 24.

● Circuit diagram example

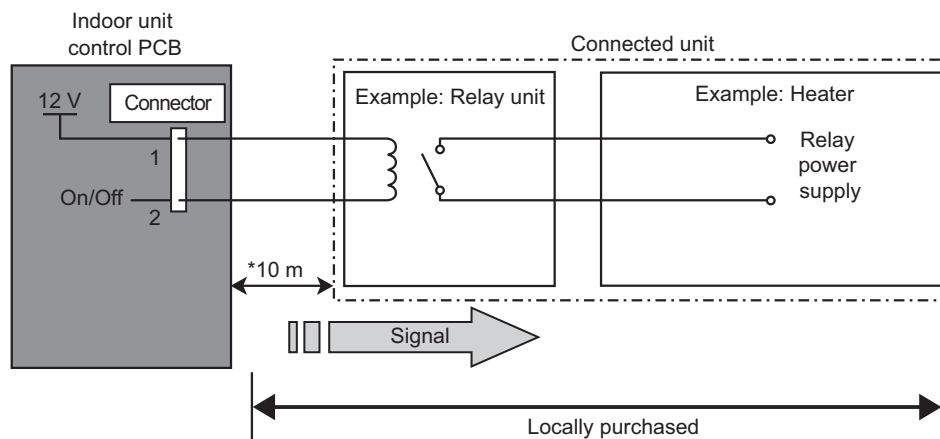

- *: Make the distance from the PCB to the connected unit within 10 m.
- Relay spec: Rated DC 12 V, 50 mA or less.

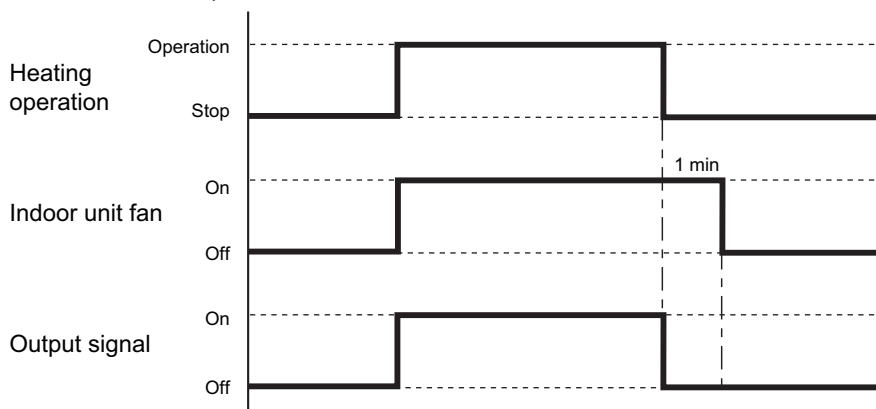

⚠ CAUTION

- Place an external heater between the indoor unit and the outlet.

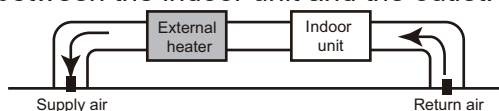

- Be sure to use delay control of the fan.

● Optional part

Model name	Exterior
UTD-ECS5A	Heater output wire 

9. Function settings

To adjust the functions of this product according to the installation environment, various types of function settings are available.

NOTE: Incorrect settings can cause a product malfunction.

9-1. Models: ARXG45KHTA and ARXG54KHTA

By using some components on the PCB, you can change the function settings.

Related components on the PCB and the applicable settings

Component			Setting content
DIP switch	SW1	1	Setting change prohibited
		2	
		3	
		4	
	SW2	1	
		2	
3			
Rotary switch	SW3	—	Remote controller address setting
Jumper wire		JM1	Setting change prohibited
		JM2	
		JM3	Fan delay setting

● Component location

Components on the indoor unit main PCB used for the function settings are located as shown in the following figure.

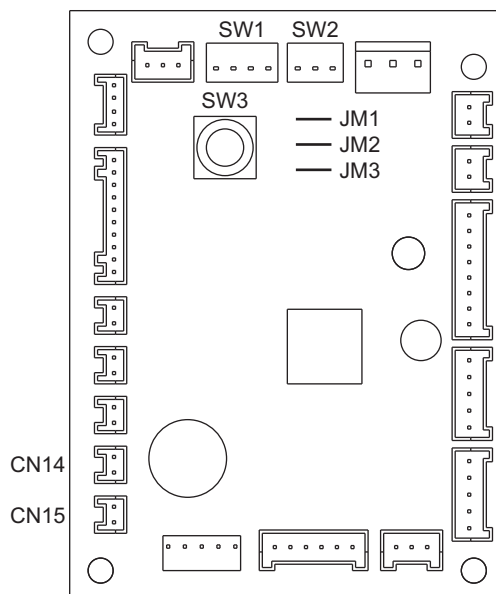

● Remote switch setting

- **Remote controller address setting (SW3)**

This switch can be used when group control system. Set the remote controller address in the 1,2,-,15 order.

SW3	SW state	Factory setting
0	Single	◆
1—15	Remote controller address	

● Jumper wire setting

- **JM1 and JM2 setting prohibited**

- **Fan delay setting (JM3)**

When the indoor unit is stopped while operating in conjunction with auxiliary heater, the indoor unit fan operation will continue for one minute.

JM3	JM state	Factory setting
Connect	Disable	◆
Disconnect	Enable	

9-2. Function settings by using remote controller

Some function settings can be changed on the remote controller. After confirming the setting procedure and the content of each function setting, select appropriate functions for your installation environment.

■ Setting procedure by using remote controller

Remote controller is not attached for this product. For details of the installing remote controller, refer to following information.

- Overview information: Operating manual of the remote controller
- Setting procedure: Installation manual of the remote controller

■ Contents of function setting

Each function setting listed in this section is adjustable in accordance with the installation environment.

NOTE: Setting will not be changed if invalid numbers or setting values are selected.

● Function setting list

	Function no.	Functions
1)	11	Filter sign
2)	30	Room temperature sensor control for cooling
3)	31	Room temperature sensor control for heating
4)	40	Auto restart
5)	42	Room temperature sensor switching
6)	46	External input control
7)	48	Room temperature sensor switching (Aux.)
8)	49	Indoor unit fan control for energy saving for cooling
9)	51	Primary and secondary settings

1) Filter sign

Select appropriate intervals for displaying the filter sign on the indoor unit according to the estimated amount of dust in the air of the room.

If the indication is not required, select "No indication" (03).

Function number	Setting value	Setting description	Factory setting
11	00	Standard (2,500 hours)	
	01	Long interval (5,000 hours)	
	02	Short interval (1,250 hours)	
	03	No indication	◆

2) Room temperature sensor control for cooling

Depending on the installed environment, correction of the room temperature sensor may be required. Select the appropriate control setting according to the installed environment.

Function number	Setting value	Setting description	Factory setting
30	00	Standard	◆
	01	Higher control	
	02	Slightly lower control	
	03	Lower control	

3) Room temperature sensor control for heating

Depending on the installed environment, correction of the room temperature sensor may be required. Select the appropriate control setting according to the installed environment.

Function number	Setting value	Setting description	Factory setting
31	00	Standard	◆
	01	Higher control	
	02	Slightly higher control	
	03	Lower control	

4) Auto restart

Enables or disables automatic restart after a power interruption.

Function number	Setting value	Setting description	Factory setting
40	00	Enable	◆
	01	Disable	

NOTE: Auto restart is an emergency function such as for power outage etc. Do not attempt to use this function in normal operation. Be sure to operate the unit by remote controller or external device.

5) Room temperature sensor switching

(Only for wired remote controller)

When using the wired remote controller temperature sensor, change the setting to "Both" (01).

Function number	Setting value	Setting description	Factory setting
42	00	Indoor unit	◆
	01	Both	

00: Sensor on the indoor unit is active.

01: Sensors on both indoor unit and wired remote controller are active.

NOTE: Remote controller sensor must be turned on by using the remote controller.

6) External input control

"Operation/Stop" mode or "Forced stop" mode can be selected.

Function number	Setting value	Setting description	Factory setting
46	00	Operation/Stop mode	◆
	01	(Setting prohibited)	
	02	Forced stop mode	

7) Room temperature sensor switching (Aux.)

To use the temperature sensor on the wired remote controller only, change the setting to "Wired remote controller" (01).

This function will only work if the function setting 42 is set at "Both" (01).

When the setting value is set to "Both" (00), more suitable control of the room temperature is possible by setting function setting 30 and 31 too.

Function number	Setting value	Setting description	Factory setting
48	00	Both	◆
	01	Wired remote controller	

8) Indoor unit fan control for energy saving for cooling

Enables or disables the power-saving function by controlling the indoor unit fan rotation when the outdoor unit is stopped during cooling operation.

Function number	Setting value	Setting description	Factory setting
49	00	Disable	
	01	Enable	
	02	Remote controller	◆

00: When the outdoor unit is stopped, the indoor unit fan operates continuously following the setting on the remote controller.

01: When the outdoor unit is stopped, the indoor unit fan operates intermittently at a very low speed.

02: Enable or disable this function by remote controller setting.

NOTES:

- As the factory setting, this setting is initially activated.
- Set to "00" or "01" when connecting a remote controller that cannot set the Fan control for energy saving function or connecting a network converter.
To confirm if the remote controller has this setting, refer to the operating manual of each remote controller.







9) Primary and secondary settings

Set the indoor unit that is connected to the outdoor unit using a transmission cable as the primary.

Function number	Setting value	Setting description	Factory setting
51	00	Primary	◆
	01	Secondary	

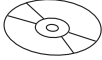

10. Accessories

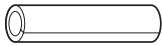
10-1. Models: ARXG45KHTA and ARXG54KHTA

Part name	Exterior	Q'ty	Part name	Exterior	Q'ty
Operating manual		1	Coupler heat insulation (small)		1
Operating manual (CD-ROM)		1	Special nut A (large flange)		4
Installation manual		1	Special nut B (small flange)		4
Coupler heat insulation (large)		1			

11. Optional parts

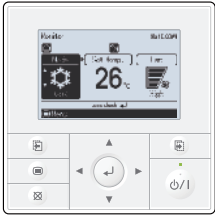
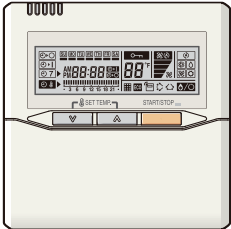





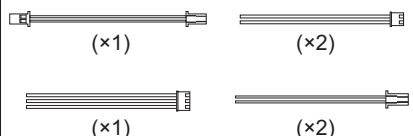

11-1. Controllers

Exterior	Part name	Model name	Summary
	Wired Remote Controller	UTY-RVNYM	Large and full-dot liquid crystal screen, wide and large keys easy to press, user-intuitive arrow key. Wire type: Polar 3-wire
	Wired Remote Controller	UTY-RNNYM	Room temperature can be controlled by detecting the temperature accurately with thermo sensor. Wire type: Polar 3-wire
	Simple Remote Controller	UTY-RSNYM	Compact remote controller concentrates on the basic functions such as Start/Stop, fan control, temperature setting, and operation mode. Wire type: Polar 3-wire

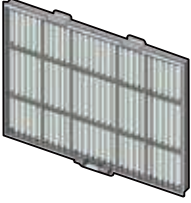
NOTES:

- Available functions may differ by the remote controller. For details, refer to the operation manual.
- When using the group controlling system of the Wired Remote Controller, using WLAN Adapter is prohibited.

11-2. Others

Exterior	Part name	Model name	Summary
 <p>(x1) (x2) (x1) (x2)</p>	External connect kit	UTD-ECS5A	Use to connect with various peripheral devices and air conditioner PCB. (Set of 6)
	Remote Sensor Unit	UTY-XSZX	Thermo-sensor for sensing the temperature of arbitrary place in the room.
	Long-life Filter	UTD-LF60KA	Long-life Filter can be mounted to the indoor unit.
	WLAN Adapter	UTY-TFNXZ1	Remotely manage an air conditioning system using mobile devices such as smartphones and tablets. Appropriate application for each region is required to use this option. For details, contact FGL sales company.
	Modbus Converter	UTY-VMSX	For connection between indoor unit with UART interface and a Modbus open network.
	KNX Converter	UTY-VKSX	For connection between indoor unit with UART interface and a KNX open network.
	Network Converter	UTY-VTGX	This converter is required when connecting single split system to VRF network system.
	Network Converter (AC power supply)	UTY-VTGXV	This converter is required when connecting single split system to VRF network system.
	External Switch Controller	UTY-TERX	Air conditioner switching can be controlled by connecting other external sensor switches.

Part 2. OUTDOOR UNIT

SINGLE TYPE:

AOYG45KRTA

AOYG54KRTA

1. Specifications

Type				Inverter heat pump	
Model name				AOYG45KRTA	AOYG54KRTA
Power supply				3N 400 V ~ 50 Hz	
Power supply intake				Outdoor unit	
Available voltage range				342—457 V	
Starting current				7.6	8.5
Fan	Airflow rate	Cooling	m ³ /h	4,450	
		Heating		4,450	
	Type × Q'ty		Propeller × 1		
	Motor output		W		
Sound pressure level *1	Cooling	dB (A)		57	
		Heating		57	59
Sound power level	Cooling	dB (A)		71	73
		Heating		71	73
Heat exchanger type	Dimensions (H × W × D)		mm	Main1: 966 × 905 × 18.20 Main2: 966 × 905 × 18.20 Sub: 966 × 543 × 18.20	
	Fin pitch			Main1: 1.45 Main2: 1.45 Sub: 1.45	
	Rows × Stages			Main1: 1 × 46 Main2: 1 × 46 Sub: 1 × 46	
	Pipe type			Copper	
	Fin			Aluminum	
	Surface treatment			Blue fin	
Compressor	Type × Q'ty		DC Twin rotary × 1		
	Motor output		W		
Refrigerant	Type (Global warming potential)		R32 (675)		
	Factory charge		g		
Refrigerant oil	Type		RmM68AF		
	Amount		cm ³		
Enclosure	Material		Steel sheet		
	Color		Beige Approximate color of Munsell 10YR 7.5/1.0		
Dimensions (H × W × D)	Net		mm	998 × 940 × 320	
	Gross			1,176 × 1,027 × 445	
Weight	Net		kg	67	
	Gross			77	
Connection pipe	Size	Liquid	mm (in)	Ø 9.52 (3/8)	
		Gas		Ø 15.88 (5/8)	
	Method		Flare		
	Pre-charge length		30		
	Max. length		50		
	Max. height difference		30		
Operation range	Cooling	°C		-15 to 46	
		Heating		-15 to 24	
Drain hose	Material		LDPE		
	Tip diameter		mm		
Ø 13.0 (I. D.), Ø 16.0 to Ø 16.7 (O. D.)					
NOTES:					
<ul style="list-style-type: none"> • Specifications are based on the following conditions: <ul style="list-style-type: none"> – Cooling: Indoor temperature of 27 °CDB/19 °CWB, and outdoor temperature of 35 °CDB/24 °CWB. – Heating: Indoor temperature of 20 °CDB/15 °CWB, and outdoor temperature of 7 °CDB/6 °CWB. – Pipe length: 5.0 m, Height difference: 0 m. (Between outdoor unit and indoor unit.) • Protective function might work when using it outside the operation range. • *1: Sound pressure level <ul style="list-style-type: none"> – Measured values in manufacturer's anechoic chamber. – Because of the surrounding sound environment, the sound levels measured in actual installation conditions might be higher than the specified values here. • This data is based on EN 14511 standard. 					

2. Dimensions

2-1. Models: AOYG45KRTA and AOYG54KRTA

Unit: mm

OUTDOOR UNIT
AOYG45, 54KRTA

OUTDOOR UNIT
AOYG45, 54KRTA

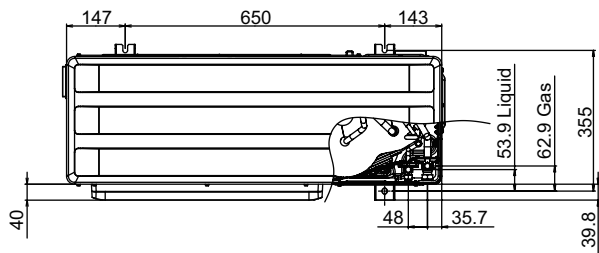

Top view

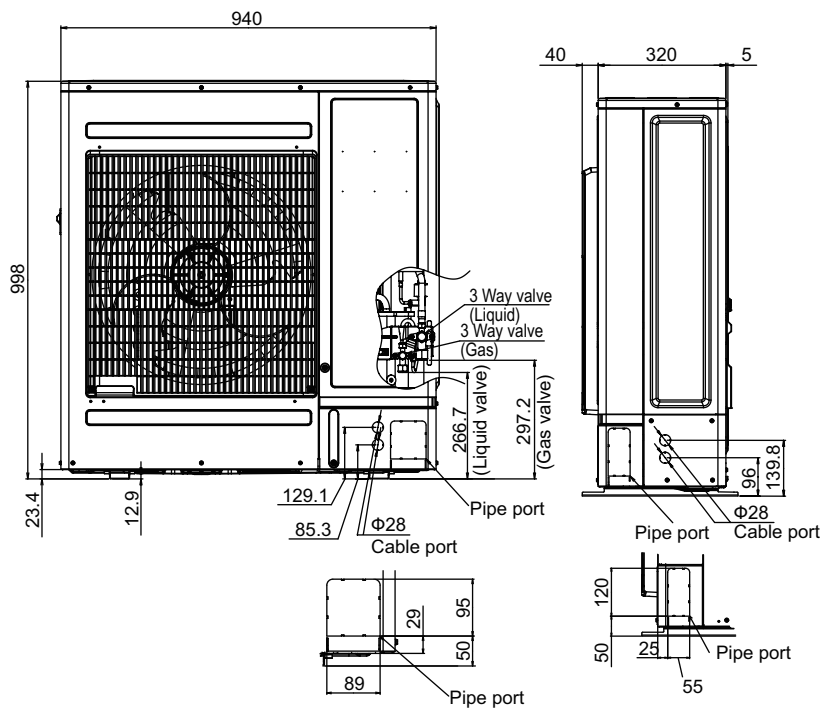

Front view

Side view

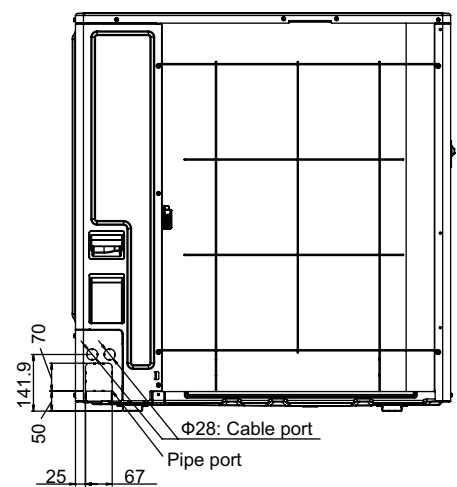

Rear view

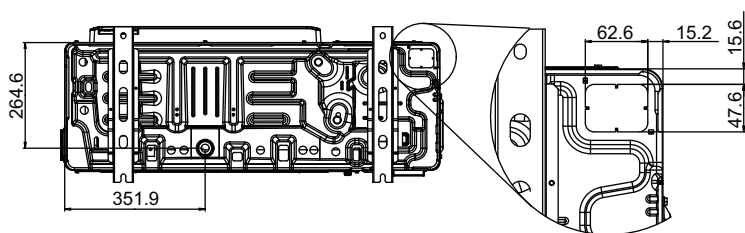

Bottom view

Pipe & Cable port

3. Installation space

3-1. Models: AOYG45KRTA and AOYG54KRTA

■ Space requirement

Provide sufficient installation space for product safety.

● Single outdoor unit installation

- When the upper space is open:

Unit: mm

When there are obstacles at the rear only.

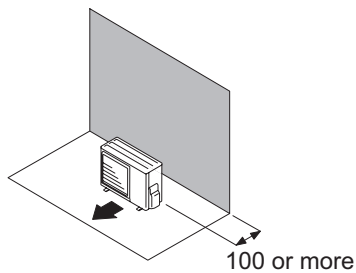

When there are obstacles at the rear and sides.

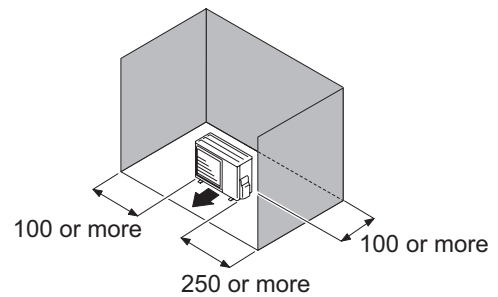

When there are obstacles at the front only.

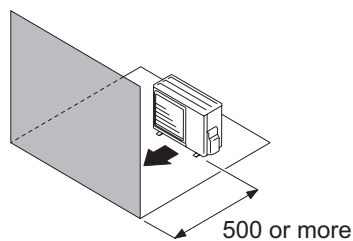

When there are obstacles at the front and rear.

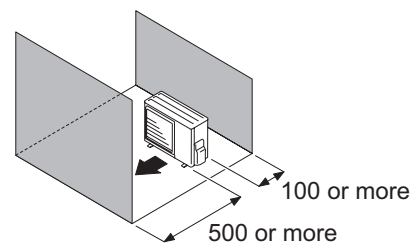

- When there is an obstruction in the upper space:

Unit: mm

When there are obstacles at the rear and above.

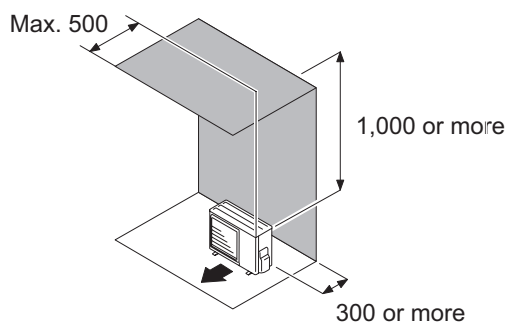

When there are obstacles at the rear, sides, and above.

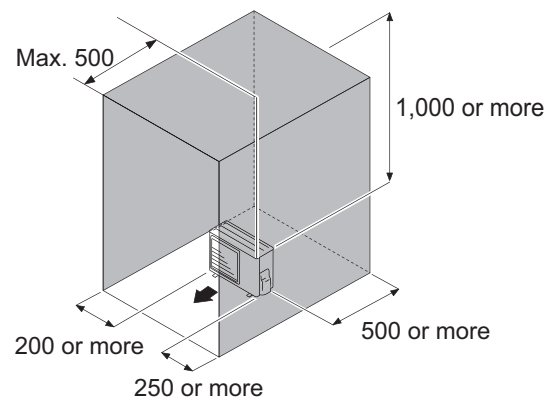

● Multiple outdoor unit installation

- When the upper space is open:

Unit: mm

When there are obstacles at the rear only.

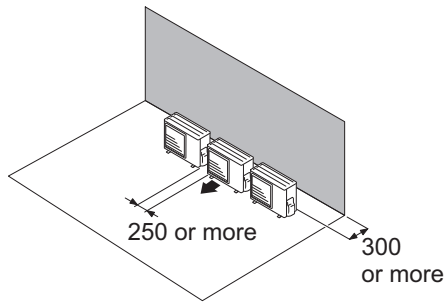

When there are obstacles at the front only.

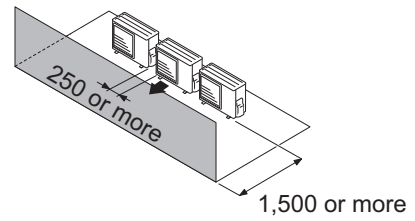

When there are obstacles at the front and rear.

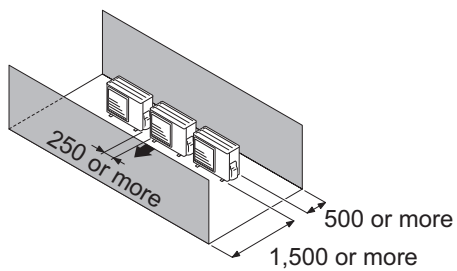

- When there is an obstruction in the upper space:

Unit: mm

When there are obstacles at the rear and above.

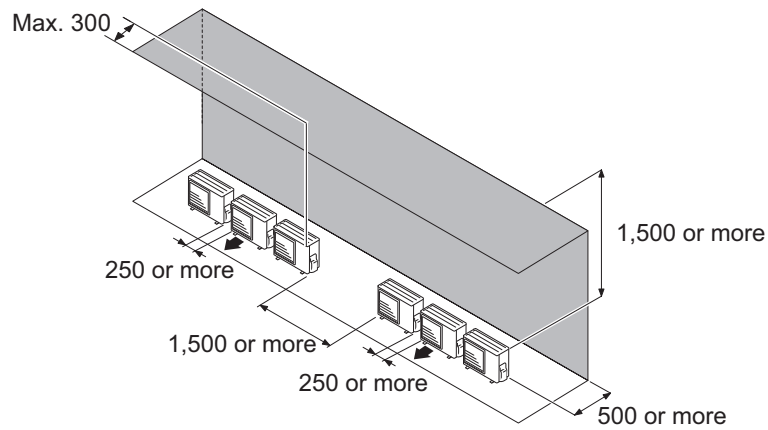

OUTDOOR UNIT
AOYG45, 54KRTA

OUTDOOR UNIT
AOYG45, 54KRTA

● Outdoor unit installation in multi-row

Unit: mm

Single parallel unit arrangement

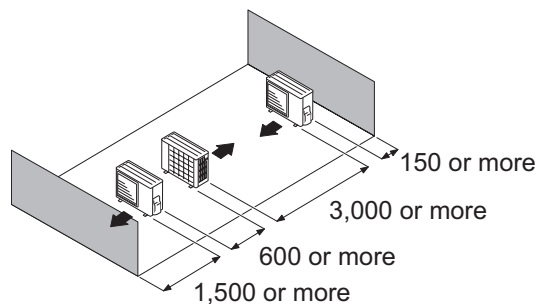

Multiple parallel unit arrangement

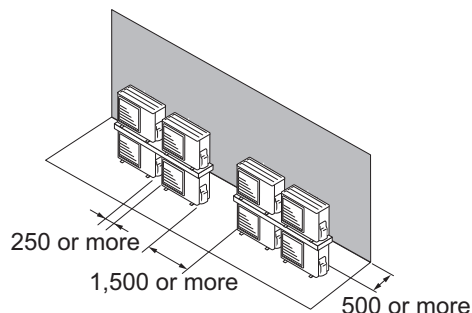
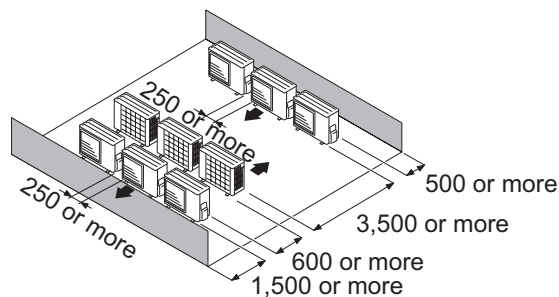

NOTES:

- If the space is larger than stated above, the condition will be the same as when there is no obstacle.
- Height above the floor level should be 50 mm or more.
- When installing the outdoor unit, be sure to open the front and left side to obtain better operation efficiency.

⚠ CAUTION

- Do not install the outdoor unit in two-stage where the drain water could freeze. Otherwise the drainage from the upper unit may form ice and cause a malfunction of the lower unit.
- When the outdoor temperature is 0 °C or less, do not use the accessory drain pipe and drain cap. If the drain pipe and drain cap are used, the drain water in the pipe may freeze in extremely cold climate. (For reverse cycle model only.)
- In area with heavy snowfall, if the inlet and outlet of the outdoor unit is blocked with snow, it might become difficult to get warm, and it is likely to cause product malfunction. Construct a canopy and a pedestal, or place the unit on a high stand that is locally installed.

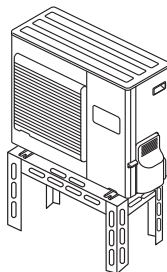

4. Refrigerant circuit

4-1. Models: AOYG45KRTA and AOYG54KRTA

OUTDOOR UNIT
AOYG45, 54KRTA

OUTDOOR UNIT
AOYG45, 54KRTA

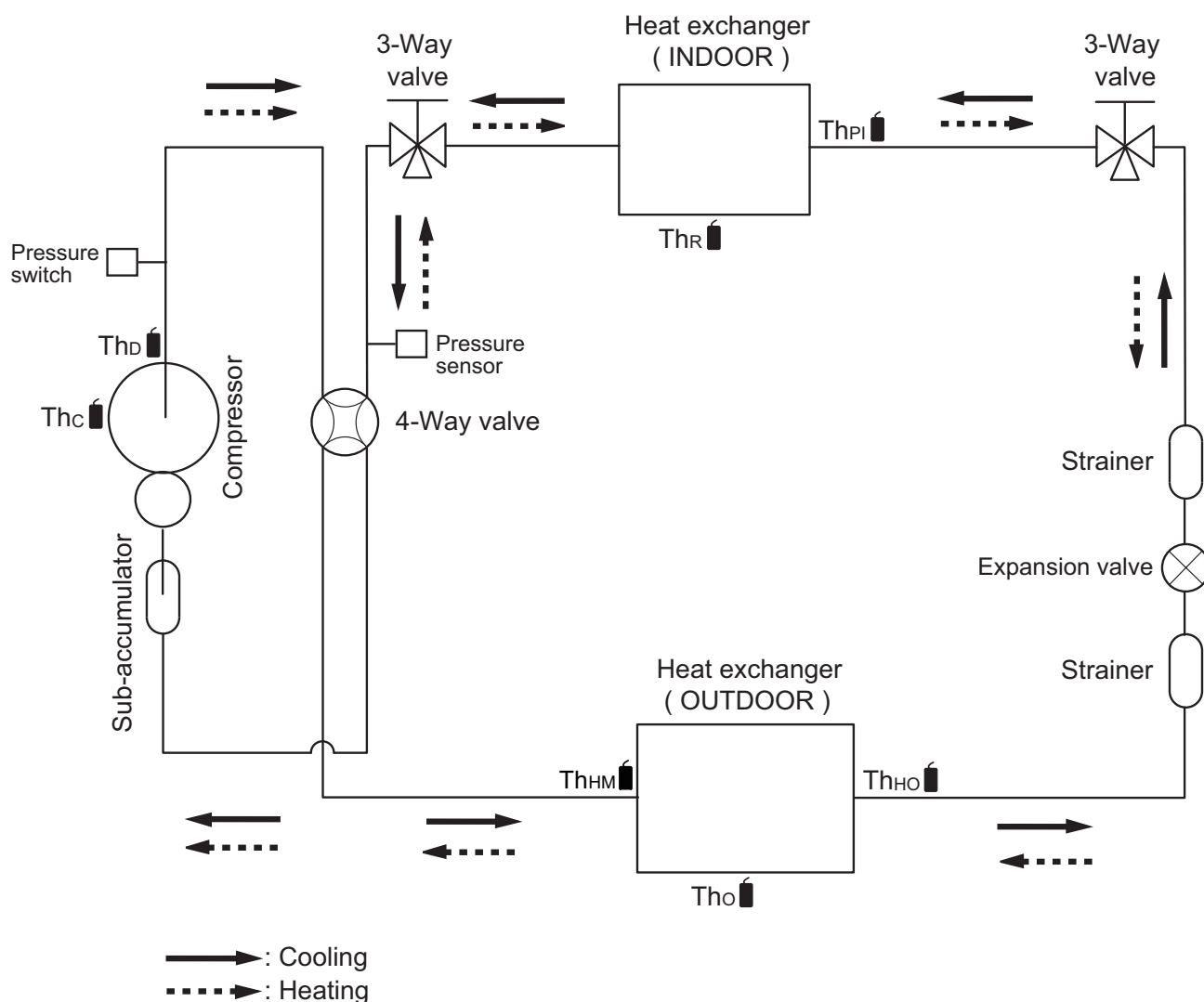

- Th_c : Thermistor (Compressor temperature)
- Th_d : Thermistor (Discharge temperature)
- Th_{HM} : Thermistor (Heat Exchanger Med temperature)
- Th_o : Thermistor (Outdoor temperature)
- Th_{HO} : Thermistor (Heat Exchanger Out temperature)
- Th_R : Thermistor (Room temperature)
- Th_{PI} : Thermistor (Pipe temperature)

5. Wiring diagrams

5-1. Models: AOYG45KRTA and AOYG54KRTA

OUTDOOR UNIT
AOYG45, 54KRTA

OUTDOOR UNIT
AOYG45, 54KRTA

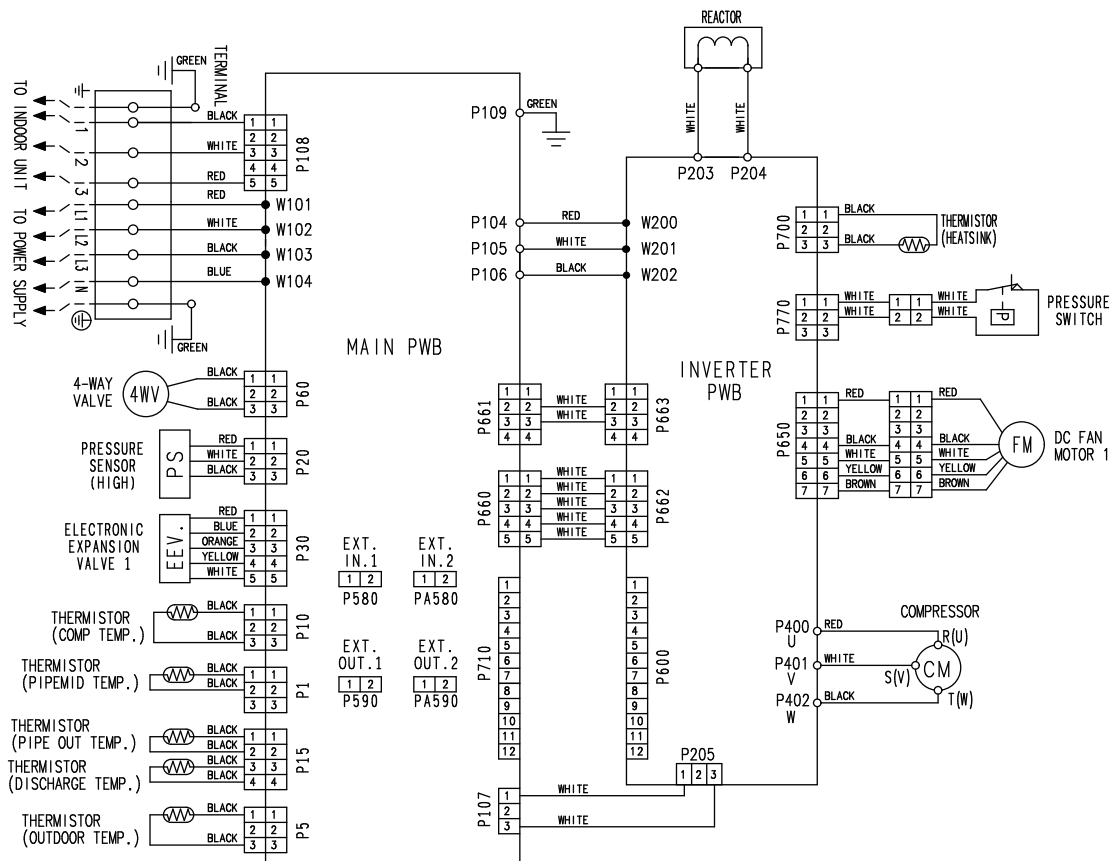

6. Capacity compensation rate for pipe length and height difference

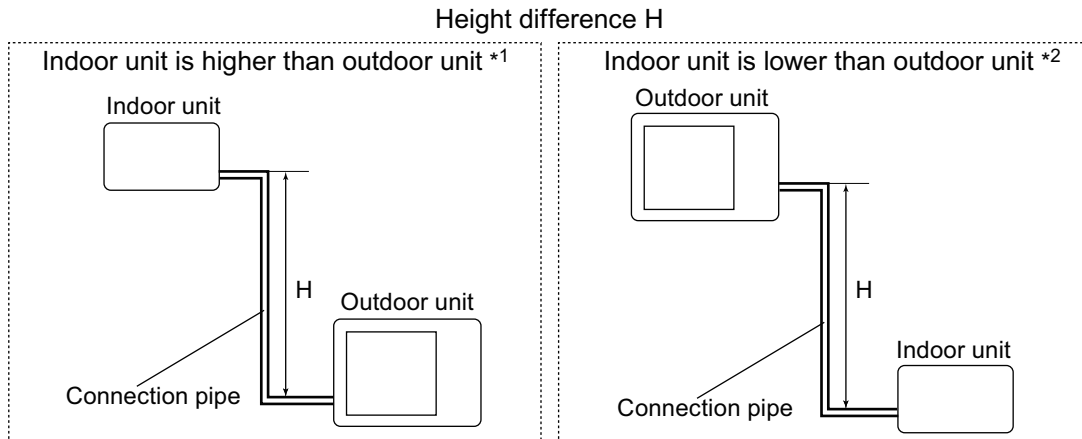

OUTDOOR UNIT
AOYG45, 54KRTA

OUTDOOR UNIT
AOYG45, 54KRTA

6-1. Models: AOYG45KRTA and AOYG54KRTA

NOTE: Values mentioned in the table are calculated based on the maximum capacity.

COOLING			Pipe length (m)						
			5	7.5	10	20	30	40	50
Height difference H (m)	Indoor unit is higher than outdoor unit *1	30	—	—	—	—	0.900	0.879	0.858
		20	—	—	—	0.937	0.915	0.894	0.872
		10	—	—	0.973	0.952	0.931	0.908	0.887
		7.5	—	0.988	0.977	0.956	0.934	0.913	0.891
		5	0.992	0.992	0.981	0.960	0.938	0.916	0.894
	Indoor unit is lower than outdoor unit *2	0	1.000	1.000	0.989	0.967	0.945	0.923	0.901
		-5	1.000	1.000	0.989	0.967	0.945	0.923	0.901
		-7.5	—	1.000	0.989	0.967	0.945	0.923	0.901
		-10	—	—	0.989	0.967	0.945	0.923	0.901
		-20	—	—	—	0.967	0.945	0.923	0.901
		-30	—	—	—	—	0.945	0.923	0.901

HEATING			Pipe length (m)						
			5	7.5	10	20	30	40	50
Height difference H (m)	Indoor unit is higher than outdoor unit *1	30	—	—	—	—	0.978	0.968	0.958
		20	—	—	—	0.988	0.978	0.968	0.958
		10	—	—	0.998	0.988	0.978	0.968	0.958
		7.5	—	1.000	0.998	0.988	0.978	0.968	0.958
		5	1.000	1.000	0.998	0.988	0.978	0.968	0.958
	Indoor unit is lower than outdoor unit *2	0	1.000	1.000	0.998	0.988	0.978	0.968	0.958
		-5	0.995	0.995	0.993	0.983	0.973	0.963	0.953
		-7.5	—	0.993	0.991	0.981	0.971	0.961	0.951
		-10	—	—	0.988	0.978	0.968	0.958	0.948
		-20	—	—	—	0.968	0.958	0.949	0.939
		-30	—	—	—	—	0.949	0.939	0.929

7. Additional charge calculation

7-1. Models: AOYG45KRTA and AOYG54KRTA

Refrigerant type	R32		
Factory charge amount	g	2,700	

■ Refrigerant charge

Total pipe length	m	30 or less	40	50 (Max.)	40 g/m
Additional charge amount	g	0	400	800	

8. Airflow

8-1. Models: AOYG45KRTA and AOYG54KRTA

● Cooling

m ³ /h	4,450
l/s	1,236
CFM	2,619

● Heating

m ³ /h	4,450
l/s	1,236
CFM	2,619

9. Operation noise (sound pressure)

9-1. Noise level curve

Model: AOYG45KRTA

● Cooling

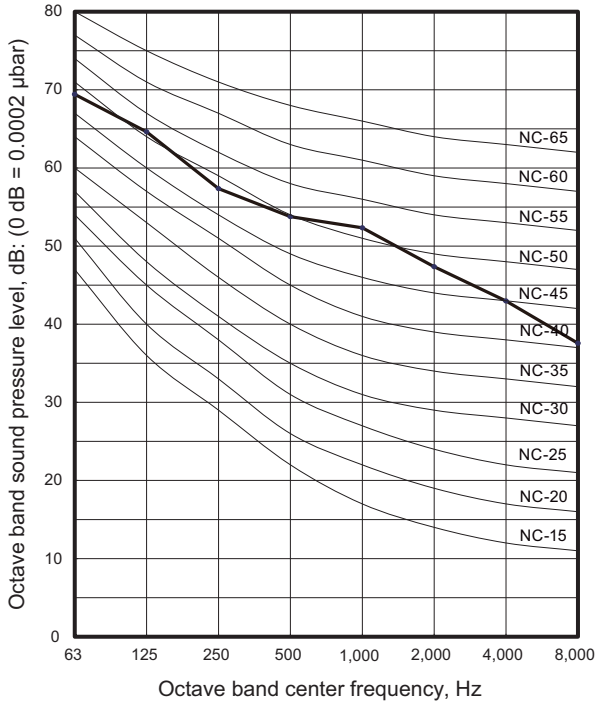

● Heating

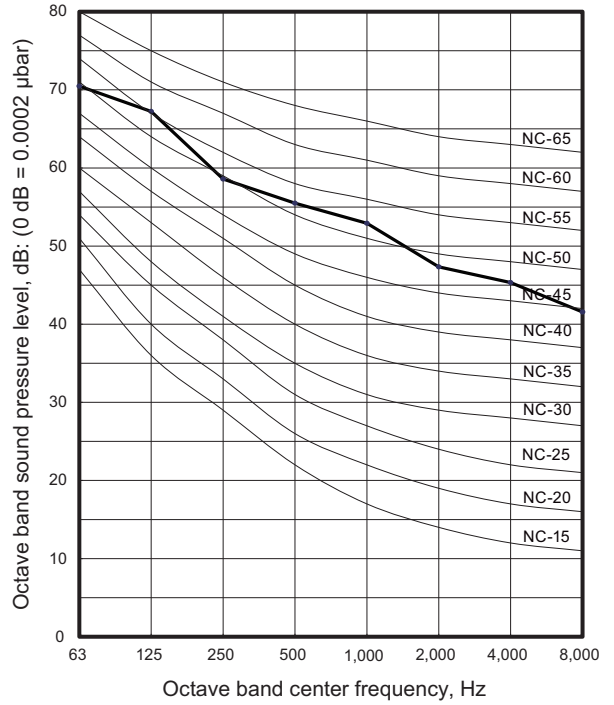

Model: AOYG54KRTA

● Cooling

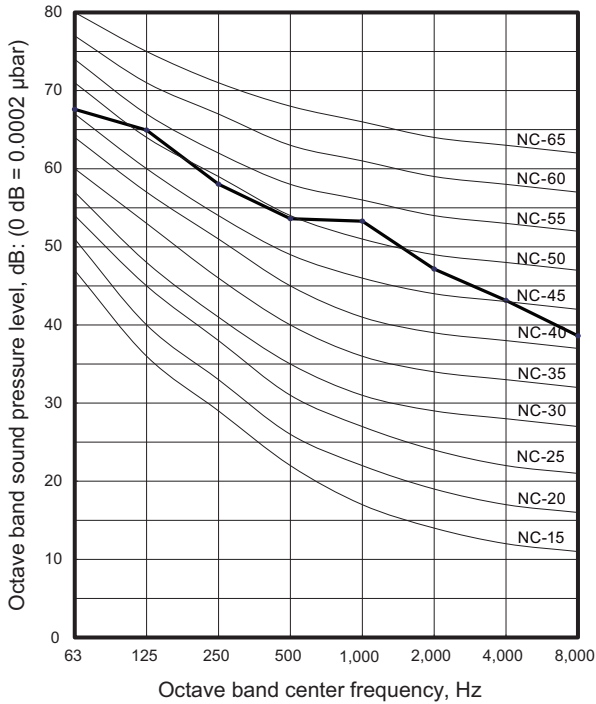

● Heating

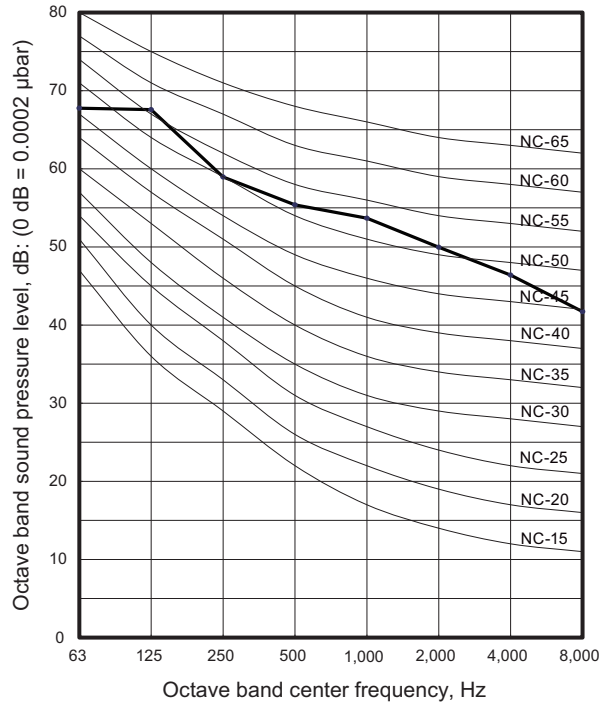

OUTDOOR UNIT
AOYG45, 54KRTA

OUTDOOR UNIT
AOYG45, 54KRTA

9-2. Sound level check point

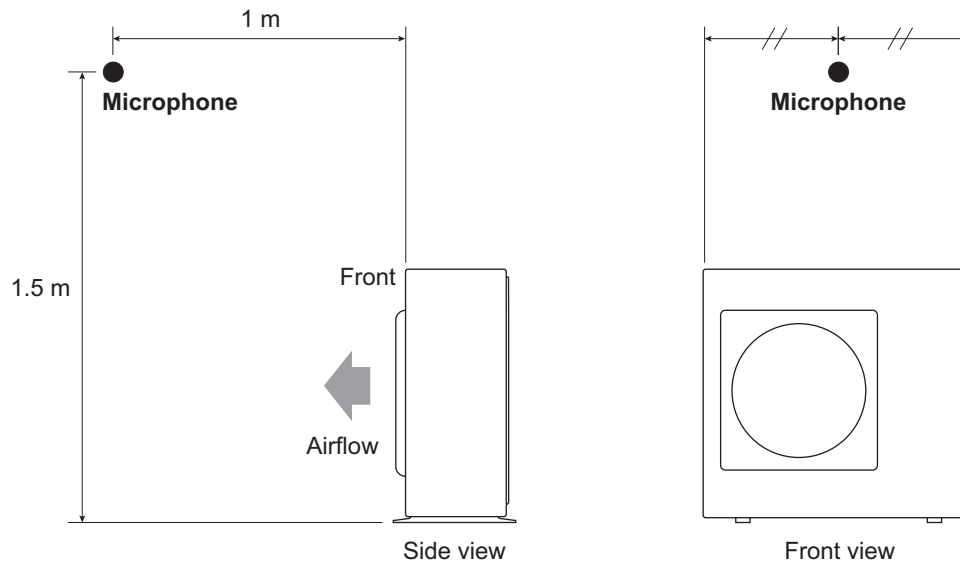

NOTE: Detailed shape of the actual outdoor unit might be slightly different from the one illustrated above.

10. Electrical characteristics

Model name			AOYG45KRTA	AOYG54KRTA	
Power supply	Voltage	V	3N 400 ~		
	Frequency	Hz	50		
Max operating current *1		A	14		
Starting current		A	7.6	8.5	
Wiring spec. *2	Circuit breaker current		A	16	
	Power cable		mm ²	2.5	
	Connection cable *3	Cross-sectional area	mm ²	1.5	
		Limited wiring length	m	51	

*1: Maximum current is the total current of the indoor unit and the outdoor unit.

*2: Selected sample based on Japan Electrotechnical Standards and Codes Committee E0005. As the regulations of wire size and circuit breaker differ in each country or region, select appropriate devices complied to the regional standard.

*3: Limit voltage drop to less than 2%. Increase conductor size if voltage drop is 2% or more.

11. Safety devices

Type of protection	Protection form		Model
			AOYG45KRTA AOYG54KRTA
Circuit protection	Current fuse (Main PCB)		250 V, 30 A × 2 250 V, 10 A × 2
Fan motor protection	Thermal protection program	Activate	150 ±15 °C Fan motor stop
		Reset	120 ±15 °C Fan motor restart
Compressor protection	Thermal protection program (Discharge temp.)	Activate	110 °C Compressor stop
		Reset	After 7 minutes Compressor restart
	Thermal protection program (Compressor temp.)	Activate	108 °C Compressor stop
		Reset	80 °C or less Compressor restart
	Thermal protection program (Outdoor temp.)	Activate	-20 °C Compressor stop
		Reset	-15 °C Compressor restart
High pressure protection	Pressure switch	Activate	4.2 ⁺⁰ _{-0.15} MPa Compressor stop
		Reset	3.2 ±0.15 MPa Compressor restart

12. External input and output

With using external input and output functions, this product can be operated inter-connectedly with an external device.

Connector	Input	Output	Remarks
P580	Low noise mode	—	See external input/output settings for details.
PA580	Peak cut mode	—	
P590	—	Error status	
PA590	—	Compressor status	

12-1. External input

With using external input function, on/off status of “Low noise mode” and “Peak cut mode” can be specified by the external signal.

■ Low noise mode

In following condition, the operating noise of the outdoor unit reduces comparing from the one in normal operating condition:

The air conditioner is set to the “Low noise mode” when closing the contact input of a commercial timer or on/off switch to a connector on the control PCB of the outdoor unit.

NOTE: Product performance may drop depending on some conditions such as the outdoor temperature.

• Circuit diagram example

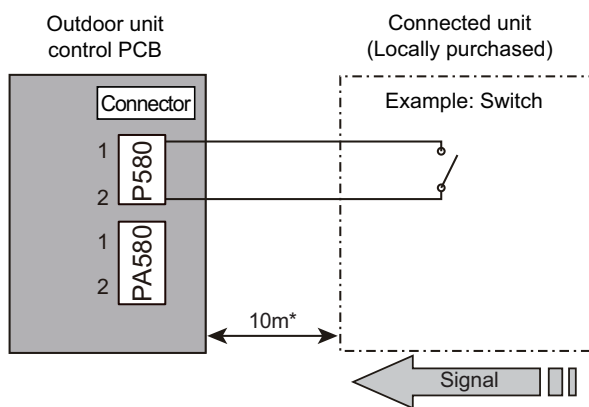

- Contact capacity: DC 24 V or more, 10 mA or more.
- *: Make the distance from the PCB to the connected unit within 10 m.
- Construct a circuit as shown in this figure with using optional parts mentioned below.
- Input signal: On in “Low noise mode”
- Input signal: Off in normal operation
- To set the level of “Low noise mode”, refer to ["Low noise mode"](#) on page 54.

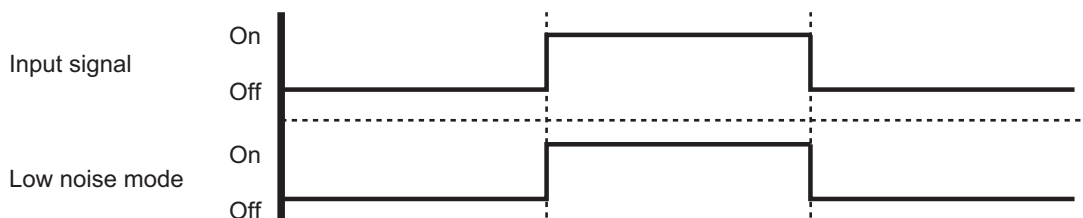

• Optional part

Part name	Model name	Exterior
External Connect Kit	UTY-XWZXZ3	External input wire 

■ Peak cut mode

By performing following on-site work, operation that suppresses the current value can be enabled: The air conditioner is set to the “Peak cut mode” when closing the contact input of a commercial timer or on/off switch to a connector on the control PCB of the outdoor unit.

• Circuit diagram example

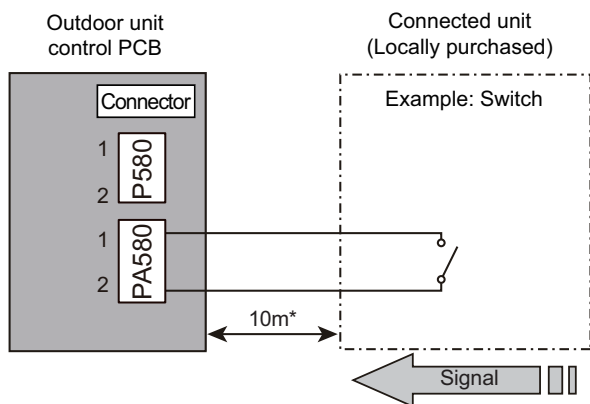

- Contact capacity: DC 24 V or more, 10 mA or more.
- *: Make the distance from the PCB to the connected unit within 10 m.
- Construct a circuit as shown in this figure with using optional parts mentioned below.
- Input signal: On in “Peak cut mode”
- Input signal: Off in normal operation
- To set the level of “Peak cut mode”, refer to “Peak cut mode” on page 55.

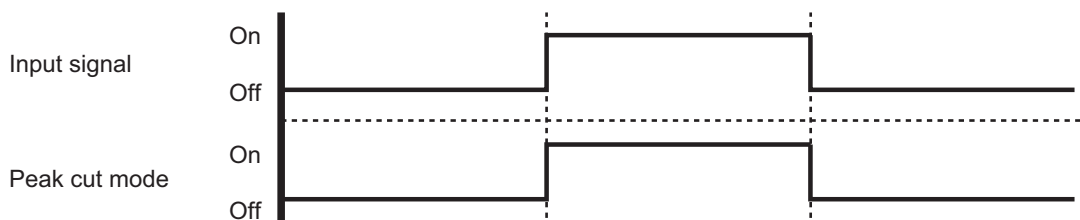

• Optional part

Part name	Model name	Exterior
External Connect Kit	UTY-XWZXZ3	External input wire 

12-2. External output

With using external output function, some status signals are transmitted to the control PCB, and the related LED lamp indicates the status of this product.

■ Error status output

Signal on air conditioner error status is generated when a malfunction occurs.

• Circuit diagram example

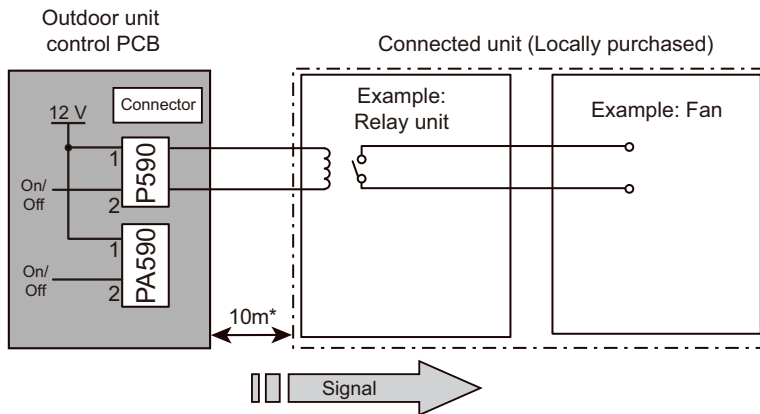

- Output voltage (Vcc): DC 12 V 50 mA or less
- *: Make the distance from the PCB to the connected unit within 10 m.

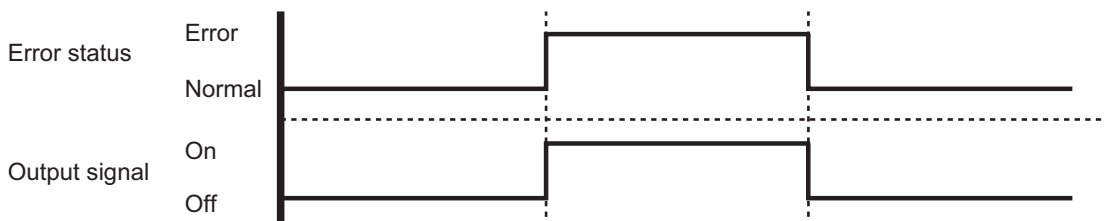

• Optional part

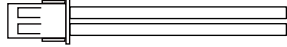
Part name	Model name	Exterior
External Connect Kit	UTY-XWZXZ3	External output wire 

Compressor status output

Signal on compressor operation status is generated when the compressor is running.

Circuit diagram example

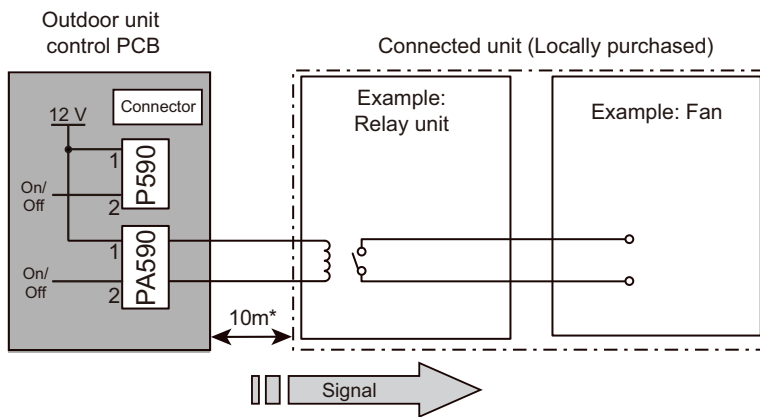

- Output voltage (Vcc): DC 12 V 50 mA or less
- *: Make the distance from the PCB to the connected unit within 10 m.

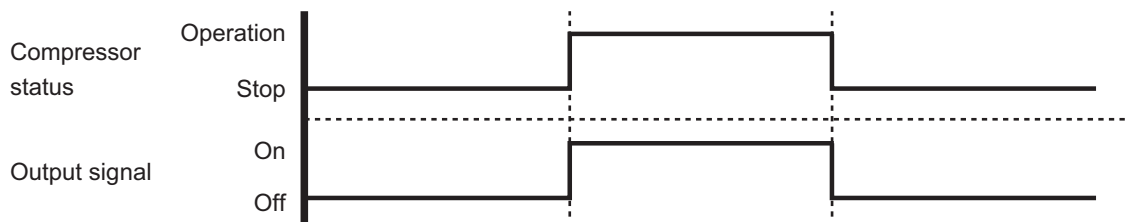

Optional part

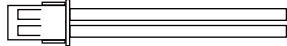
Part name	Model name	Exterior
External Connect Kit	UTY-XWZXZ3	External output wire 

13. Function settings

Perform appropriate function setting locally according to the installation environment.

NOTE: Incorrect settings can cause a product malfunction.

⚠ CAUTION

- Before setting up the switch buttons, discharge the static electricity from your body.
- Never touch the terminals or the patterns on the parts that are mounted on the PCB.

13-1. Control PCB and switch buttons location

Control PCB of the outdoor unit is located as shown in the following figure.

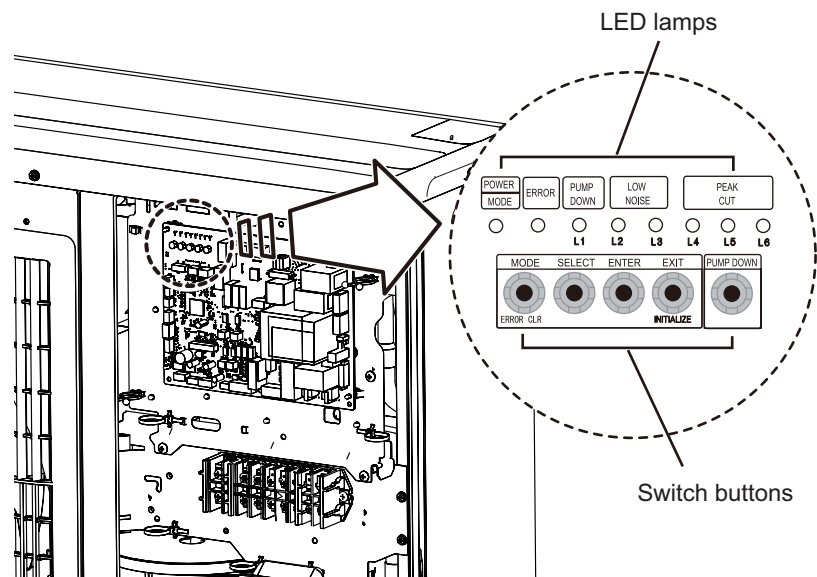

■ Switch buttons and the functions

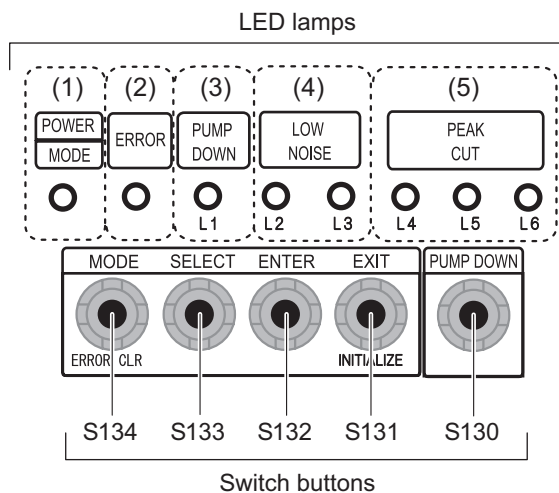

LED lamp			Function or operation method
(1)	POWER/MODE	Green	Lights on while power on. Blinks to show the local setting on the outdoor unit or the error code.
(2)	ERROR	Red	Blinks during error operation.
(3)	PUMP DOWN (L1)	Orange	Lights on during pump down operation.
(4)	LOW NOISE MODE (L2 and L3)	Orange	Lights on during "Low noise mode" when local setting is activated. (Light pattern of L2 and L3 indicates the low noise level.)
(5)	PEAK CUT MODE (L4, L5, and L6)	Orange	Lights on during "Peak cut mode" when local setting is activated. (Light pattern of L4, L5, and L6 indicates the peak cut level.)

Switch button			Function or operation method
S134	MODE		Switches between "Local setting" and "Error code display".
S133	SELECT		Switches between the individual "Local settings" and the "Error code displays".
S132	ENTER		Switches between the individual "Local settings" and the "Error code displays".
S131	EXIT		Returns to "Operation status display".
S130	PUMP DOWN		Starts the pump down operation.

13-2. Local setting procedure

NOTE: Before performing the function setting, be sure to stop the operation of the air conditioner.

Low noise mode

1. Press the MODE switch button (S134) for 3 seconds or more to switch to "Local setting mode".
2. After confirming the LED lamp of POWER/MODE blinks 9 times, press the ENTER switch button (S132).

POWER MODE	ERROR	PUMP DOWN (L1)	LOW NOISE (L2) (L3)		PEAK CUT (L4) (L5) (L6)		
Blinks (9 times)	○	○	○	○	○	○	○

Sign "○": Lights off

3. Press the SELECT switch button (S133), and adjust the LED lamp as shown below. Then the LED lamp indicates the current setting.

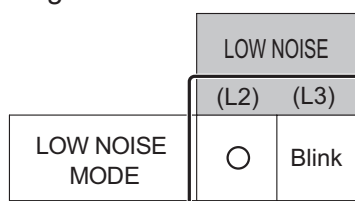

4. Press the ENTER switch button (S132).

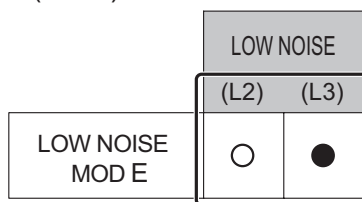

Sign "●": Lights on

5. Press the SELECT switch button (S133), and adjust the LED lamps as shown below.

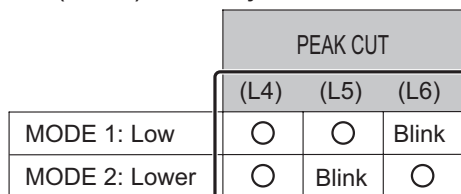

6. Press the ENTER switch button (S132) and fix it.

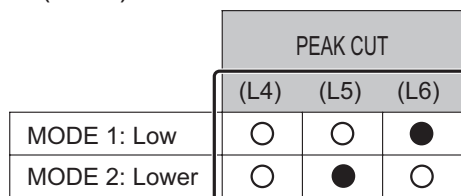

7. To return to "Operating status display (Normal operation)", press the EXIT switch button (S131).

In case of missing how many times you pressed the SELECT and ENTER switch buttons:

1. To return to "Operation status display (Normal operation)", press the EXIT switch button once.
2. Restart from the beginning of setting procedure.

NOTE: In case of missing how many times you pressed the SELECT and ENTER switch buttons, you must redo the setting procedure. Return to "Operation status display (Normal operation)" by pressing the EXIT switch button once, and restart from the beginning of the setting procedure.

■ Peak cut mode

1. Press the MODE switch button (S134) for 3 seconds or more to switch to “Local setting mode”.
2. After confirming the LED lamp of POWER/MODE blinks 9 times, press the ENTER switch button (S132).

POWER MODE	ERROR	PUMP DOWN (L1)	LOW NOISE		PEAK CUT		
			(L2)	(L3)	(L4)	(L5)	(L6)
Blinks (9 times)	○	○	○	○	○	○	○

Sign “○”: Lights off

3. Press the SELECT switch button (S133), and adjust the LED lamp as shown below. Then the LED lamp indicates the current setting.

		LOW NOISE	
		(L2)	(L3)
PEAK CUT MODE	Blink	○	○

4. Press the ENTER switch button (S132).

		LOW NOISE	
		(L2)	(L3)
PEAK CUT MODE	●	○	○

Sign “●”: Lights on

5. Press the SELECT switch button (S133), and adjust the LED lamps as shown below.

	PEAK CUT		
	(L4)	(L5)	(L6)
0 % of rated input ratio	○	○	Blink
50 % of rated input ratio	○	Blink	○
75 % of rated input ratio	○	Blink	Blink
100 % of rated input ratio	Blink	○	○

6. Press the ENTER switch button (S132) and fix it.





	PEAK CUT		
	(L4)	(L5)	(L6)
0 % of rated input ratio	○	○	●
50 % of rated input ratio	○	●	○
75 % of rated input ratio	○	●	●
100 % of rated input ratio	●	○	○

7. To return to “Operating status display (Normal operation)”, press the EXIT switch button (S131).

NOTE: When pressed number is lost during setting, you must redo the setting procedure. Return to “Operation status display (Normal operation)” by pressing the EXIT switch button once, and restart from the beginning of the setting procedure.

14. Accessories

14-1. Models: AOYG45KRTA and AOYG54KRTA

Part name	Exterior	Q'ty	Part name	Exterior	Q'ty
Installation manual		1	Drain cap		3
Drain pipe		1	One-touch bush		2

15. Optional parts

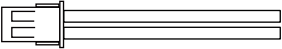
Exterior	Part name	Model name	Summary
 A technical drawing of an external connect kit, showing a rectangular connector with three pins on the left side and a long, thin rectangular body extending to the right.	External Connect Kit	UTY-XWZXZ3	Use to operate the external input and output functions of outdoor unit.